



NGER PLATFORM TO ENHANCE CUSTOMER SERVICE
PRYSMIAN GROUP LEADING TECHNOLOGY
FIRE PRYSMIAN GROUP WORLDWIDE LEA
FIRE PERFORMANCE CABLES NDED PROD
DING TECHNOLOGY STRONGER PLATFORM
WORLDWIDE LEADER

Prysmian
Group



CONNECTING ENERGY AND INFORMATION TO GLOBAL GROWTH

Welcome to the Prysmian Group, the world's leading cable solutions provider.

Over 130 years of aggregated history, 22,000 people in 50 countries and almost 97 plants are the best possible platform for driving change and innovation. Operating through two of the industry's most respected global brands, Prysmian and Draka, we are ready to connect with our customers and help them respond to their present and future challenges. We enable them to bring their services to homes and businesses, cities and entire countries.

VISION

We believe in the effective, efficient and sustainable supply of Energy and Information as a primary driver in the development of communities.

MISSION

We provide our customers worldwide with superior cable solutions based on state-of-the-art technology and consistent excellence in execution, ultimately delivering sustainable growth and profit.

VALUES

Excellence.
Integrity.
Understanding.

We are powered by a clear vision and an ambitious mission. We are guided by the belief in the efficient, effective and sustainable supply of energy and information as a driver in the development of communities. We are linking the future.

CONTENTS

MAX-FOH	7
LSHF : LOW SMOKE HALOGEN-FREE CABLES	29
TECHNICAL INFORMATION	38

Why Fire Performance Cables are so important?

Major accidents which have resulted in the deaths of many innocent people, have taught us that the safety of the occupants are users in public, commercial and industrial environments is of paramount importance. Every possible safety feature designed to prevent and protect against loss of life and damage to property should be specified and installed.

One such safety feature in the use of fire performance cables for critical safety system, including fire alarms, emergency lighting, PA systems, CCTV systems, emergency power supplies and smoke & fire shutters.

The correct selection and installation of these "life saving" cables helps ensure that in the event of an emergency, vital safety system will continue to operate to assist an orderly evacuation of the premises and to aid the emergency services in gaining quick and effective entry to deal with the hazard.

At Prysmian Group, we understand what is required from a fire performance cable and we appreciate the pressures faces by specifiers and consultants in selecting the correct cable from the range available. For nearly twenty years, our special cables have been servicing the needs of the market by designing and manufacturing the widest range of fire performance cables available today.

APPLICATION

Our fire performance cables are specifically designed to facilitate the quick and orderly evacuation of the building occupants in the events of an emergency. Purpose designed to maintain circuit integrity to a host of critical safety systems, including fire alarms, emergency lights, CCTV systems and emergency power supplied, MAX-FOH cables from a vital component of any safety system. The special characteristics of the MAX-FOH range make it suitable for an almost infinite number of application and environments. The diagram below illustrated the main safety systems which should be fitted with either 300/500V or 600/1000V MAX-FOH cables.

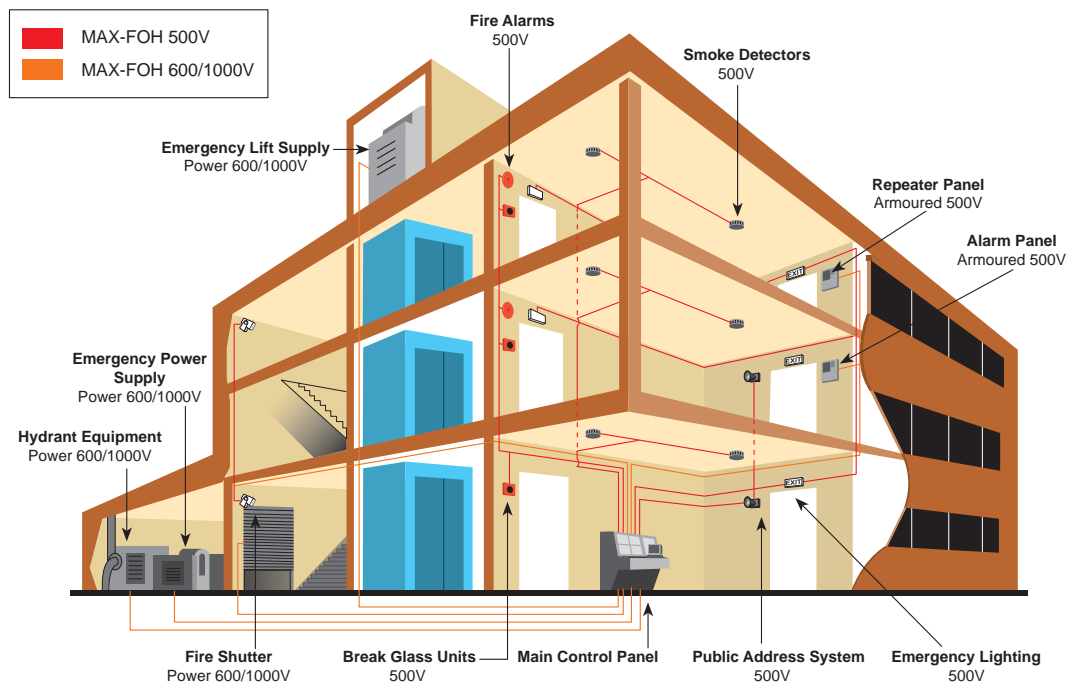

Choosing The Right Cables, and The Right Manufacturer

Issues to take note when comparing with other cables,

1. Some brands are OEM cables and carry certifications from the original manufacturers.
2. Some conductors used may be undersized conductors, and hence cheaper.
3. Some brands use only one layer of mica tape for all conductors size with less than the recommended over-lapping.
4. Insulation used is cheaper PVC instead of LSHF material, hence the cable is actually not Low Smoke Halogen Free compliant.
5. Cheaper polymers are used to reduce cost, but are without sufficient flame and smoke suppressant.
6. Thickness of insulation and sheathing are thinner to reduce cost.
7. Other cables may only have in-house testing reports and not certifications from a recognised 3rd party verification agency.

Safety is NEVER a compromise when it comes to fire protection!



Any cable breakage or short circuited in any FIRE condition can lead to the loss of human "lives". Therefore, all cabling on critical systems must be of Fire Performance type.

WITH OUR MAX-FOH CABLE YOU CAN BE SURE YOUR SYSTEMS WILL WORK!







MAX-FOH

CE EXTENDED PRODUCT OFFER
WORLDWIDE LEA
SUPPORTING GLOBAL UTILITIES IN THE D
OF SMARTER AND GREENER POWER GR
STRONGER PLATFORM



BS 6387/SS 299 Part 1: 1994 - Fire, Fire with Water & Fire with Mechanical Shock Tests

The following test is the nationally recognised United Kingdom and Singapore test used to determine if a cable is capable of maintaining circuit integrity under fire conditions, fire with water and fire with mechanical shock. These tests use a number of alternative time and temperature parameters and depending on the level achieved by the cable, a corresponding letter is assigned to denote the category the cable passed.

Resistance to fire:	Symbol
650°C for 3 hours	A
750°C for 3 hours	B
950°C for 3 hours	C
950°C for 20 minutes	S



Resistance to fire and water:	Symbol
650°C for 15 minutes, then for 15 minutes with fire and water	W



Resistance to fire with mechanical shock:	Symbol
650°C for 15 minutes, with 30 second hammer blows	X
750°C for 15 minutes, with 30 second hammer blows	Y
950°C for 15 minutes, with 30 second hammer blows	Z



During the tests the cables are energised at their rated voltage.
MAX-FOH cables meet the highest categories of BS 6387 i.e. C, W & Z

IEC 61034 - Smoke Density Test

This test measures the smoke emission from electric cables during fire. The test is carried out in a 3m cubed chamber where a cable sample is subjected to fire.

The smoke emission and density are measured by transmitting a beam of light across the inside of the chambers to a photo electric cell which measures the amount of light received.

All MAX-FOH cables comply to IEC 61034 requirements.

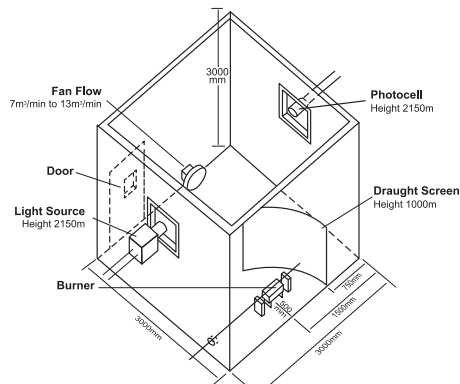

IEC 60754 – Acid Gas Emission Test

Due to the concern regarding the amount of acid gas which could be produced when cables are burnt, this international test was developed to determine the amount of gas evolved by burning cables.

The recommended values of the test state that the weighted pH value should not be less than 4.3, when related to 1 litre of water. The weighted value of conductivity should not exceed 10us/mm.

MAX-FOH cables meet the above requirements.



IEC 60331 – Fire Test

The international fire test is designed to establish whether a cable can maintain circuit integrity during and after exposure to fire.

A sample of cable is exposed to fire for 90 minutes at a temperature of between 750°C and 800°C, after 90 minutes the fire is extinguished and the current is turned off. After a further 12 hours, the sample of cable is re-energized and must maintain its circuit integrity.

MAX-FOH cables meet the requirements of IEC 60331



IEC 60332 Part 3 - Flame Propagation Test

This test defines the ability of bunched cables to restrict vertical flame propagation when laid in trunking, cable trays or conduit. The test comprises of 3 categories each determined by the amount of combustible material in a 1 metre sample, as shown in the table below.

Category	A	B	C	D
No. of litres of combustible material in a 1 metre sample.	7	3.5	1.5	0.5
Exposure (mins)	40	40	20	20

The cable samples are placed vertically next to one another on a vertical ladder where they are exposed to fire from a ribbon gas burner for the pre-arranged times.

After burning, the samples are wiped clean to examine for char (the crumbling) of the cable surface. The charring should not have reached a height exceeding 2.5m above the bottom edge of the burner.

MAX-FOH cables meet the requirement of IEC 60332 part 3

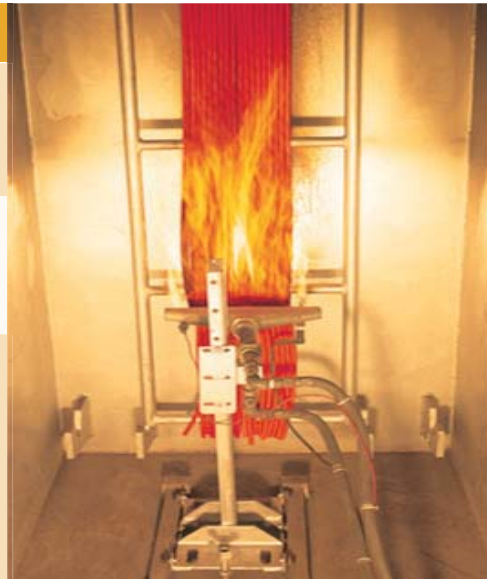

Additional Considerations

As well as requirements written into international and British cable standards, there are other essential criteria which designers and consultants need to consider – is the cable able to withstand voltage spikes, transmit data and prevent flame propagation?

All MAX-FOH cables do comply with these additional benefits, including the added advantage that MAX-FOH requires fewer joints in a cable run compare to mineral, reducing the risk of weak links in the chain. MAX-FOH does not require complicated terminations and is therefore quicker and easier to install.

CONSTRUCTION OF CABLE

Construction	MAX-FOH 500 Multi-Cores	MAX-FOH-OSCR 500V Twisted pair	MAX-FOH 0.6/1KV	MAX-FOH-I 0.6/1KV	MAX-FOH-125 0.6/1KV
1 - Conductor	Stranded annealed copper	Stranded annealed copper	Stranded annealed copper	Stranded annealed copper	Stranded annealed copper
2 - Fire Barrier	Mica tape	Mica tape	Mica tape	Mica tape	Mica tape
3 - Insulation	Cross-linked polyethylene (XLPE)	Cross-linked polyethylene (XLPE)	Cross-linked polyethylene (XLPE)	Cross-linked EVA** (XLEVA) (Orange)	Cross-linked EVA** (XLEVA)
4 - Shield*	Optional*	Aluminium foil with tinned copper drain wire	Aluminium foil with tinned copper drain wire	-	Aluminium foil with tinned copper drain wire
5 - Filler*	LSHF filler or polypropylene split yam	LSHF filler or polypropylene split yam	LSHF filler or polypropylene split yam	-	LSHF filler or polypropylene split yam
6 - Binder Tape*	Polyester tape	Polyester tape	Polyester tape	-	Polyester tape
7 - Bedding*	Low smoke halogen free (LSHF) compound (Black)	Low smoke halogen free (LSHF) compound (Black)	Low smoke halogen free (LSHF) compound (Black)	-	Low smoke halogen free (LSHF) compound (Black)
8 - Armour*/#	Galvanised steel wire (aluminium or copper wire for single core)	Galvanised steel wire (aluminium or copper wire for single core)	Galvanised steel wire (aluminium or copper wire for single core)	-	Galvanised steel wire (aluminium or copper wire for single core)
9 - Sheath	Low Smoke halogen free (LSHF) compound (Orange)	Low Smoke halogen free (LSHF) compound (Orange)	Low smoke halogen free (LSHF) compound (Orange)	-	Low Smoke halogen free (LSHF) compound (Orange)

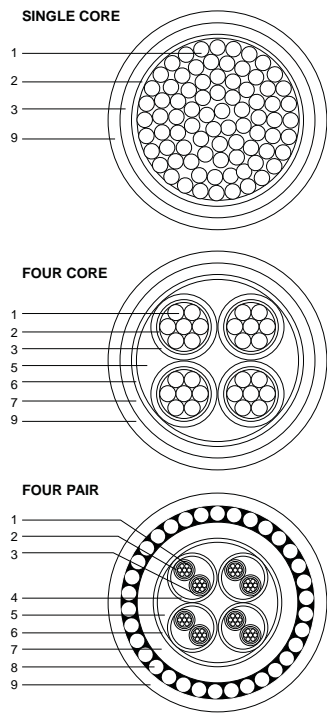

* Optional: Depending on requirement
 # Braided armour also available on request
 ** XLEVA (Cross-linked Ethylene Vinyl Acetate) material used are suitable for operating temperature of 110°C up to 125°C
 - XLPE (Cross-linked Polyethylene) material used for operating temperature of 90°C

No. of cores	Identification of cores	
	Option 1	Option 2
1	Natural	Other colour on request
2	Brown, Blue	Red, Black
3	Brown, Black, Grey	Red, Yellow Blue
4	Brown, Black, Grey, Blue	Red, Yellow, Blue, Black
5	Brown, Black, Grey, Blue, Green/Yellow	Red, Yellow, Blue, Black, Green/Yellow
6 and above	Black with white numbering	

Note: Special construction and design to customers' specification can be upon request.

Applicable Standards

IEC 60502-1 AS/NZS 3198	Extruded solid dielectric insulated power cable for rated voltage of 1 kV up to 30kV
IEC 60228 BS 6360 AS/NZS 1125	Conductors of insulated cables
IEC 60754-1 BS 6425-2 AS/NZS 1160.5	Test on gases evolved during combustion of electric cables – Determination of the amount of halogen acid gases
IEC 60754-2 BS 6426-2 AS/NZS 1160.5.4	Test on gases evolved during combustion of electric cables – Determination of degree of acidity of gases evolved by measuring pH and conductivity
IEC 60331 AS/NZS 1160.5.5	Fire resistant characteristics of electric cable (750°C for 90 minutes)
IEC 60332 Part 1 BS 4066 Part 1	Test on electric cables under fire conditions – Test on a single vertical insulated wire or cable
IEC 60332 Part 3 BS 4066 Part 3 Category A,B,C/ AS/NZS 1660.5.1	Test on electric cables under fire conditions – Test on bunched wires or cables
IEC 61034 BS 7622 AS/NZS 1660.5.2	Measurement of smoke density of electric cables burning under defined conditions
BS 6387 SS 299 Part 1	Performance requirements for cables required to maintain circuit integrity under fire condition – Category C : tested at 950°C for 3 hours Category W: fire with water Category Z : fire with mechanical shock
BS 6724	Armoured cables for electricity supply having thermosetting insulation with low emission of smoke and corrosive gases when affected by fire
BS 7211	Thermosetting insulated cables (non-armoured) for electric power and lighting with low emission of smoke and corrosive gases when affected by fire
BS 7846	600/1000V armoured fire-resistant electric cables having low emission of smoke and corrosive gases when affected by fire
AS/NZS 3013	Electrical installations – Classification of the fire and mechanical performance of wiring systems

* Standards applied will vary depending on cable construction.

Comparison between test standards IEC 60331 Part 21 & SS 299 Part 1

Ref	Description of tests	IEC 60331 Part 21	0.6/1kV cables	Data cables	Optical fibre cables	SS 299 Part 1	0.6/1kV cables	Data cables	Optical fibre cables
1	Resistance to FIRE alone								
	Flame temperature / Duration	750°C/90 min	✓	✓	✓	Cat A- 650 °C/3hr Cat B- 750 °C/3hr Cat C- 950 °C/3hr Cat S- 650°C/20min	✓ ✓ ✓ ✓		
2	Resistance to FIRE with mechanical shock								
	Flame temperature / Duration	830°C/120 min	✓			Cat X- 650 °C/3hr Cat Y - 750°C/3hr Cat Z- 950 °C/3hr	✓ ✓ ✓		
	Mechanical shock	Every 5 min	✓			Every 30 sec	✓		
3	Resistance to FIRE with water spray								
	Flame temperature / Duration	Not available				Cat W- 650°C/15min	✓		
4	Other tests								
	Electrical requirements for completed cables	Not available				Available	✓		
	Bending characteristics	Not available				Available	✓		
	Resistance of cable to impact	Not available				Available	✓		

MAX-FOH
Insulated and sheathed
500Vac. Unarmoured and
Armoured

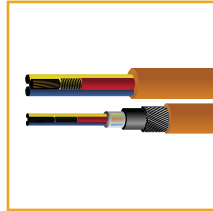

MAX-FOH (OSCR)
Insulated and sheathed
500Vac. Unarmoured and
Armoured with Shield

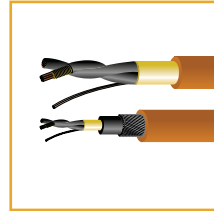

Conductor:	Plain stranded annealed copper Class 2	Plain stranded annealed copper Class 2
	0.5mm ² up to 4 mm ²	0.5mm ² up to 2.5 mm ²
Fire Barrier :	Mica Glass Tape	Mica Glass Tape
Insulation :	XLPE compound	XLPE compound
Bedding :	LSHF compound	LSHF compound
Shield :	Optional	Aluminium foil with tinned copper drain wire
Armouring :	Optional	Optional
Sheath :	LSHF compound	LSHF compound
UV Resistance :	Optional	Optional
Anti-Termite :	Optional	Optional
Anti-Rodent :	Optional	Optional
Insulation Colours :	Blue, Brown, Black, Grey	Black & White +numbering
Bedding Colours :	Black	Black
Sheath Colours :	Orange (Standard)	Orange (Standard)
Reference Standard :	BS EN 50288-7	BS EN 50288-7
Voltage : U ₀ /U	500V	500V
Circuit Integrity : Up to 1 mm ²	IEC 60331-21, SS 299-1	IEC 60331-21, SS 299-1
1.5mm ² up to Max. mm ²	IEC 60331-21, SS 299-1 BS 6387 Cat C, W, Z	IEC 60331-21, SS 299-1 BS 6387 Cat C, W, Z
<u>Test Standard</u>		
Flame Retardant :		
•Single vertical cable	IEC 60332-1, BS 4066-1, BS EN 50266-1	IEC 60332-1, BS 4066-1, BS EN 50266-1
•Bunched cables	IEC 60332-3 BS 4066-3, BS EN 50266-2	IEC 60332-3 BS 4066-3, BS EN 50266-2
Halogen gases :	IEC 60754-1, BS 6425-1, BS EN 50267-2-1	IEC 60754-1, BS 6425-1, BS EN 50267-2-1
Corrosiveness & Conductivity :	IEC 60754-2, BS 6425-2, BS EN 50267-2-2	IEC 60754-2, BS 6425-2, BS EN 50267-2-2
Smoke Emission :	IEC 61034-2, BS 7622-2, BS EN 61034-2	IEC 61034-2, BS 7522-2, BS EN 61034-2



500V, Unarmoured and Armoured Fire Resistant Cables

	Unarmoured Cable						Armoured Cable				
	Nominal area of conductor	No. & Diameter of wires	Insulation Thickness	Sheath Thickness	Approx. diameter overall	Approx. weight	Bedding Thickness	Armour wire diameter	Sheath Thickness	Approx. diameter overall	Approx. weight
	mm ²	No./mm	mm	mm	mm	kg/km	mm	mm	mm	mm	kg/km
Single core	0.5	7/0.30	0.6	0.8	4.8	27	-	-	-	-	-
	0.75	7/0.37	0.6	0.8	5.0	31	-	-	-	-	-
	1	7/0.43	0.6	0.8	5.2	35	-	-	-	-	-
	1.5	7/0.53	0.6	0.9	5.7	45	-	-	-	-	-
	2.5	7/0.67	0.7	0.9	6.3	59	-	-	-	-	-
	4	7/0.85	0.7	0.9	6.9	77	-	-	-	-	-
Two cores	0.5	7/0.30	0.6	1.0	8.4	89	1.0	0.9	1.4	13.6	348
	0.75	7/0.37	0.6	1.0	8.9	101	1.0	0.9	1.4	14.1	371
	1	7/0.43	0.6	1.0	9.2	112	1.0	0.9	1.4	14.4	392
	1.5	7/0.53	0.6	1.0	9.8	132	1.0	0.9	1.4	15.0	428
	2.5	7/0.67	0.7	1.1	11.3	181	1.0	0.9	1.4	15.1	454
	4	7/0.85	0.7	1.1	12.3	232	1.1	0.9	1.5	16.6	551
Three cores	0.5	7/0.30	0.6	1.0	9.0	97	1.0	0.9	1.4	14.2	368
	0.75	7/0.37	0.6	1.0	9.4	111	1.0	0.9	1.4	14.6	394
	1	7/0.43	0.6	1.0	9.8	125	1.0	0.9	1.4	15.0	418
	1.5	7/0.53	0.6	1.0	10.5	151	1.0	0.9	1.5	15.9	469
	2.5	7/0.67	0.7	1.1	12.0	208	1.0	0.9	1.5	16.0	504
	4	7/0.85	0.7	1.1	13.2	273	1.1	0.9	1.5	17.3	610
Four cores	0.5	7/0.30	0.6	1.0	9.8	112	1.0	0.9	1.4	15.0	404
	0.75	7/0.37	0.6	1.0	10.3	130	1.0	0.9	1.5	15.7	442
	1	7/0.43	0.6	1.0	10.7	146	1.0	0.9	1.5	16.1	471
	1.5	7/0.53	0.6	1.1	11.7	184	1.1	0.9	1.5	17.1	532
	2.5	7/0.67	0.7	1.1	13.2	248	1.1	0.9	1.5	17.2	578
	4	7/0.85	0.7	1.2	14.7	337	1.1	0.9	1.5	18.5	692

E Unarmoured fire resistant cables

F Armoured fire resistant cables

* Multicore unarmoured and armoured fire resistant cables are available upon request



500V, Unarmoured and Armoured Shielded Fire Resistant Cables

	Unarmoured Cable						Armoured Cable				
	Nominal area of conductor	No. & Diameter of wires	Insulation Thickness	Sheath Thickness	Approx. diameter overall	Approx. weight	Bedding Thickness	Armour wire diameter	Sheath Thickness	Approx. diameter overall	Approx. weight
	mm ²	No./mm	mm	mm	mm	kg/km	mm	mm	mm	mm	kg/km
Single pair	0.5	7/0.30	0.6	1.0	8.7	69	1.0	0.9	1.3	13.8	327
	0.75	7/0.37	0.6	1.0	9.1	78	1.0	0.9	1.3	14.2	347
	1	7/0.43	0.6	1.0	9.5	86	1.0	0.9	1.3	14.6	364
	1.5	7/0.53	0.6	1.0	10.1	101	1.0	0.9	1.3	15.2	395
	2.5	7/0.67	0.7	1.1	11.5	136	1.1	0.9	1.3	16.6	467
Two pairs	0.5	7/0.30	0.6	1.1	13.0	129	1.1	1.25	1.3	18.8	602
	0.75	7/0.37	0.6	1.2	13.9	154	1.2	1.25	1.4	19.9	666
	1	7/0.43	0.6	1.2	14.5	171	1.2	1.25	1.4	20.5	703
	1.5	7/0.53	0.6	1.2	15.5	203	1.2	1.25	1.4	21.5	768
	2.5	7/0.67	0.7	1.3	17.7	274	1.3	1.25	1.5	23.9	926
Three pairs	0.5	7/0.30	0.6	1.2	14.1	164	1.2	1.25	1.4	20.1	682
	0.75	7/0.37	0.6	1.2	14.8	188	1.2	1.25	1.4	20.8	732
	1	7/0.43	0.6	1.2	15.4	211	1.2	1.25	1.4	21.4	777
	1.5	7/0.53	0.6	1.3	16.7	263	1.3	1.25	1.5	22.9	884
	2.5	7/0.67	0.7	1.4	19.1	361	1.4	1.25	1.6	25.5	1075
Four pairs	0.5	7/0.30	0.6	1.2	15.4	195	1.2	1.25	1.4	21.4	760
	0.75	7/0.37	0.6	1.3	16.5	234	1.3	1.25	1.5	22.7	846
	1	7/0.43	0.6	1.3	17.2	264	1.3	1.25	1.5	23.4	901
	1.5	7/0.53	0.6	1.3	18.4	321	1.3	1.25	1.6	24.8	1012
	2.5	7/0.67	0.7	1.4	21.0	444	1.4	1.25	1.7	27.6	1241

G Unarmoured fire resistant cables

H Armoured fire resistant cables

* Multipairs unarmoured and armoured shielded fire resistant cables are available upon request



Conductor:	Plain stranded annealed copper Class 2 1.5mm ² up to 630 mm ² **	Plain stranded annealed copper Class 2 50mm ² up to 630 mm ² **	Plain stranded annealed copper Class 2 1.5mm ² up to 630 mm ²	Plain stranded annealed copper Class 2 1.5mm ² up to 630 mm ² **
Fire Barrier :	Mica Glass Tape	Mica Glass Tape	Mica Glass Tape	Mica Glass Tape
Insulation :	XLPE compound	XLPE compound	XLEVA compound	XLEVA compound
Bedding :	-	LSHF compound	-	-
Armouring :	-	Aluminium wire	-	-
Sheath :	LSHF compound	LSHF compound	-	LSHF compound
UV Resistance :	Optional	Optional	Optional	Optional
Anti-Termite :	Optional	Optional	Optional	Optional
Anti-Rodent :	Optional	Optional	Optional	Optional
Insulation Colours :	Natural	Natural	Orange (Standard)	White
Bedding Colours :	-	Black	-	-
Sheath Colours :	Orange (Standard)	Orange (Standard)	-	Orange (Standard)
Reference Standard :	IEC 60502-1	IEC 60502-1, BS 7846	IEC 60502-1	IEC 60502-1
Voltage : U _o /U	600/1000V	600/1000V	600/1000V	600/1000V
Circuit Integrity :	IEC 60331, SS 299-1 / BS 6387 Cat C, W, Z (for 300/500V, 450/750V, 600/1000V)	IEC 60331, SS 299-1 / BS 6387 Cat C, W, Z (for 300/500V, 450/750V, 600/1000V)	IEC 60331, SS 299-1 / BS 6387 Cat C, W, Z (for 300/500V, 450/750V, 600/1000V)	IEC 60331, SS 299-1 / BS 6387 Cat C, W, Z (for 300/500V, 450/750V, 600/1000V)
Test Standard				
Flame Retardant :				
•Single vertical cable	IEC 60332-1, BS 4066-1, BS EN 50266-1	IEC 60332-1, BS 4066-1, BS EN 50266-1	IEC 60332-1, BS 4066-1, BS EN 50266-1	IEC 60332-1, BS 4066-1, BS EN 50266-1
•Bunched cables	IEC 60332-3 BS 4066-3, BS EN 50266-2	IEC 60332-3 BS 4066-3, BS EN 50266-2	IEC 60332-3 BS 4066-3, BS EN 50266-2	IEC 60332-3 BS 4066-3, BS EN 50266-2
Halogen gases :	IEC 60754-1, BS 6425-1, BS EN 50267-2-1	IEC 60754-1, BS 6425-1, BS EN 50267-2-1	IEC 60754-1, BS 6425-1, BS EN 50267-2-1	IEC 60754-1, BS 6425-1, BS EN 50267-2-1
Corrosiveness & Conductivity :	IEC 60754-2, BS 6425-2, BS EN 50267-2-2	IEC 60754-2, BS 6425-2, BS EN 50267-2-2	IEC 60754-2, BS 6425-2, BS EN 50267-2-2	IEC 60754-2, BS 6425-2, BS EN 50267-2-2
Smoke Emission :	IEC 61034-2, BS 7622-2, BS EN 61034-2	IEC 61034-2, BS 7622-2, BS EN 61034-2	IEC 61034-2, BS 7622-2, BS EN 61034-2	IEC 61034-2, BS 7622-2, BS EN 61034-2

*XLEVA material used are suitable for operating temperature 110°C up to 125°C.

** For the cable size 800-1000mm², please contact company.

Cable Type		MAX-FOH-I				MAX-FOH			
Constructions		Insulated, non-sheathed				Insulated and sheathed			
Material Composition		Copper/MGT/XLEVA				Copper/MGT/XLPE/LSHF			
Standard		IEC 60502-1				IEC 60502-1			
Voltage		600/1000V				600/1000V			
		Unarmoured							
Single Core	Conductor cross sectional area	No. & diameter Of Wire	Insulation thickness	Cable overall diameter	Cable weight	Insulation thickness	Sheath thickness	Cable overall diameter	Cable weight
	mm ²	No/ mm	mm	mm	kg/km	mm	mm	mm	kg/km
	1 x 1.5	7/0.53	0.7	4.0	30	0.7	1.4	6.6	60
	1 x 2.5	7/0.67	0.8	4.5	40	0.7	1.4	7.0	73
	1 x 4	7/0.85	1.0	5.4	60	0.7	1.4	7.6	93
	1 x 6	7/1.04	1.0	6.0	90	0.7	1.4	8.1	120
	1 x 10	7/1.35	1.0	7.0	130	0.7	1.4	9.0	160
	1 x 16	7/1.70	1.0	8.1	190	0.7	1.4	10.1	230
	1 x 25	7/2.14	1.2	9.8	300	0.9	1.4	12.0	330
	1 x 35	19/1.53	1.2	11.0	400	0.9	1.4	13.3	450
	1 x 50	19/1.78	1.4	12.8	540	1.0	1.4	14.8	600
	1 x 70	19/2.14	1.4	14.5	740	1.1	1.4	16.7	810
	1 x 95	19/2.52	1.6	16.9	1020	1.1	1.5	18.9	1100
	1 x 120	37/2.03	1.6	18.4	1250	1.2	1.5	20.9	1340
	1 x 150	37/2.25	1.8	20.7	1540	1.4	1.6	23.1	1650
	1 x 185	37/2.52	2.0	23.0	1930	1.6	1.7	25.6	2050
	1 x 240	61/2.25	2.2	26.0	2510	1.7	1.7	28.4	2630
	1 x 300	61/2.52	2.4	28.9	3130	1.8	1.8	31.3	3260
	1 x 400	61/2.85	2.6	32.1	3960	2.0	1.9	34.7	4100
	1 x 500	61/3.20	2.8	35.8	4990	2.2	2.1	38.8	5180
1 x 630	127/2.52	2.8	39.7	6330	2.4	2.2	43.3	6590	
1 x 800	127/2.85				2.6	2.3	48.0	8300	
1 x 1000	127/3.20				2.8	2.5	53.5	10470	

Cable Type		MAX-FOH-AWA						
Constructions		Insulated, armoured and sheathed						
Material Composition		Copper/MGT/XLPE/LSHF/AWA/LSHF						
Standard		IEC 60502-1						
Voltage		600/1000V						
		Armoured						
Single Core	Conductor cross sectional area	No. & diameter Of Wire	Diameter under armour	Armour wire diameter	Sheath thickness	Cable overall diameter	Cable weight	
	mm ²	No/ mm	mm	mm	mm	mm	kg/km	
		1 x 1.5	7/0.53					
		1 x 2.5	7/0.67					
		1 x 4	7/0.85					
		1 x 6	7/1.04					
		1 x 10	7/1.35					
		1 x 16	7/1.70					
		1 x 25	7/2.14					
		1 x 35	19/1.53					
		1 x 50	19/1.78	13.8	1.25	1.5	19.5	800
		1 x 70	19/2.14	15.7	1.25	1.5	21.7	1130
		1 x 95	19/2.52	17.7	1.25	1.6	23.9	1450
		1 x 120	37/2.03	19.4	1.6	1.6	26.3	1770
		1 x 150	37/2.25	21.4	1.6	1.7	28.5	2130
		1 x 185	37/2.52	23.7	1.6	1.8	31.0	2580
		1 x 240	61/2.25	26.5	1.6	1.9	34.0	3220
		1 x 300	61/2.52	29.2	1.6	1.9	36.7	3890
		1 x 400	61/2.85	32.8	2.0	2.1	41.5	5000
		1 x 500	61/3.20	36.5	2.0	2.2	45.4	6150
	1 x 630	127/2.52	40.8	2.0	2.3	49.9	7670	
	1 x 800	127/2.85	45.7	2.5	2.5	56.2	9780	
	1 x 1000	127/3.20	50.8	2.5	2.6	61.5	12080	

MAX-FOH
Insulated and sheathed

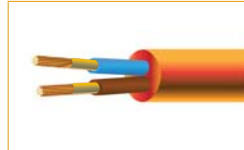

MAX-FOH-SWA
Insulated, armoured and sheathed

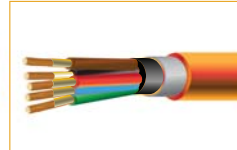

MAX-FOH-125
Insulated and sheathed

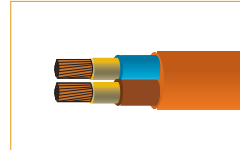

MAX-FOH-125-SWA
Insulated, armoured and sheathed

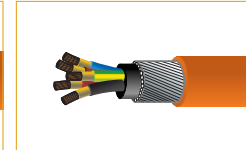

Conductor:	Plain stranded annealed Class 2 Copper.	Plain stranded annealed Class 2 Copper.	Plain stranded annealed Class 2 Copper.	Plain stranded annealed Class 2 Copper.
	1.5mm ² up to 400 mm ²	50mm ² up to 400 mm ²	1.5mm ² up to 400 mm ²	50mm ² up to 400 mm ²
Fire Barrier :	Mica Glass Tape	Mica Glass Tape	Mica Glass Tape	Mica Glass Tape
Insulation :	XLPE compound	XLPE compound	XLEVA compound	XLEVA compound
Bedding :	—	LSHF compound	—	LSHF compound
Armouring :	—	Steel wire	—	Steel wire
Sheath :	LSHF compound	LSHF compound	LSHF compound	LSHF compound
UV Resistance :	Optional	Optional	Optional	Optional
Anti-Termite :	Optional	Optional	Optional	Optional
Anti-Rodent :	Optional	Optional	Optional	Optional
Insulation Colours :	Refer to identification of core colours (page10)	Refer to identification of core colours(page10)	Refer to identification of core colours (page10)	Refer to identification of core colours (page10)
Bedding Colours :	—	Black	—	Black
Sheath Colours :	Orange (Standard)	Orange (Standard)	Orange (Standard)	Orange (Standard)
Reference Standard :	IEC 60502-1	IEC 60502-1, BS 7846	IEC 60502-1	IEC 60502-1, BS 7846
Voltage : U ₀ /U	600/1000V	600/1000V	600/1000V	600/1000V
Circuit Integrity :	IEC 60331, SS 299-1 / BS 6387 Cat C, W, Z (for 300/500V, 450/750V, 600/1000V)	IEC 60331, SS 299-1 / BS 6387 Cat C, W, Z (for 300/500V, 450/750V, 600/1000V)	IEC 60331, SS 299-1 / BS 6387 Cat C, W, Z (for 300/500V, 450/750V, 600/1000V)	IEC 60331, SS 299-1 / BS 6387 Cat C, W, Z (for 300/500V, 450/750V, 600/1000V)
<u>Test Standard</u>				
Flame Retardant :				
• Single vertical cable	IEC 60332-1, BS 4066-1, BS EN 50266-1	IEC 60332-1, BS 4066-1, BS EN 50266-1	IEC 60332-1, BS 4066-1, BS EN 50266-1	IEC 60332-1, BS 4066-1, BS EN 50266-1
• Bunched cables	IEC 60332-3 BS 4066-3, BS EN 50266-2	IEC 60332-3 BS 4066-3, BS EN 50266-2	IEC 60332-3 BS 4066-3, BS EN 50266-2	IEC 60332-3 BS 4066-3, BS EN 50266-2
Halogen gases :	IEC 60754-1, BS 6425-1, BS EN 50267-2-1	IEC 60754-1, BS 6425-1, BS EN 50267-2-1	IEC 60754-1, BS 6425-1, BS EN 50267-2-1	IEC 60754-1, BS 6425-1, BS EN 50267-2-1
Corrosiveness & Conductivity :	IEC 60754-2, BS 6425-2, BS EN 50267-2-2	IEC 60754-2, BS 6425-2, BS EN 50267-2-2	IEC 60754-2, BS 6425-2, BS EN 50267-2-2	IEC 60754-2, BS 6425-2, BS EN 50267-2-2
Smoke Emission :	IEC 61034-2, BS 7622-2, BS EN 61034-2	IEC 61034-2, BS 7622-2, BS EN 61034-2	IEC 61034-2, BS 7622-2, BS EN 61034-2	IEC 61034-2, BS 7622-2, BS EN 61034-2

* XLEVA material used are suitable for operating temperature 110°C up to 125°C.

Cable Type		MAX-FOH					MAX-FOH-SWA				
Constructions		XLPE Insulated, LSHF sheathed					XLPE Insulated, LSHF bedding, Steel wire armoured and LSHF sheathed				
		Unarmoured					Armoured				
Material Composition		Copper/MGT/XLPE/LSHF					Copper/MGT/XLPE/LSHF/SWA/LSHF				
Standard		IEC 60502-1					IEC 60502-1, BS 7846				
Voltage		600/1000V					600/1000V				
		Unarmoured					Armoured				
	Conductor cross sectional area	No. & diameter Of wire	Insulation thickness	Sheath thickness	Cable overall diameter	Cable Weight	Diameter under armour	Armour wire diameter	Sheath thickness	Cable overall diameter	Cable weight
	mm ²	No/ mm	mm	mm	mm	kg/km	mm	mm	mm	mm	kg/km
Two Cores	2 x 1.5	7/0.53	0.7	1.8	11.3	180	9.7	0.9	1.8	15.1	435
	2 x 2.5	7/0.67	0.7	1.8	12.1	210	10.5	0.9	1.8	15.9	493
	2 x 4	7/0.85	0.7	1.8	13.2	270	11.6	0.9	1.8	17.0	576
	2 x 6	7/1.04	0.7	1.8	14.3	340	12.7	1.25	1.8	18.8	777
	2 x 10	7/1.35	0.7	1.8	16.3	380	14.7	1.25	1.8	20.8	901
	2 x 16	7/1.70	0.7	1.8	19.7	540	16.9	1.25	1.8	23.5	1230
	2 x 25	7/2.14	0.9	1.8	22.5	780	20.4	1.6	1.8	27.7	1780
	2 x 35	19/1.53	0.9	1.8	25.3	1030	23.2	1.6	1.8	30.4	2150
	2 x 50	19/1.78	1.0	1.8	28.4	1320	26.3	1.6	1.9	33.7	2600
	2 x 70	19/2.14	1.1	1.8	32.4	1800	30.3	1.6	2.0	37.9	3300
	2 x 95	19/2.52	1.1	2.0	37.0	2450	34.9	2.0	2.1	43.5	4570
	2 x 120	37/2.03	1.2	2.1	40.6	3000	38.3	2.0	2.2	47.1	5310
	2 x 150	37/2.25	1.4	2.2	44.9	3710	42.4	2.0	2.4	51.6	6280
	2 x 185	37/2.52	1.6	2.3	49.8	4570	47.5	2.5	2.5	57.9	8150
	2 x 240	61/2.25	1.7	2.5	56.0	5920	53.3	2.5	2.7	64.1	9920
	2 x 300	61/2.52	1.8	2.6	61.6	7280	59.1	2.5	2.9	70.3	11790
2 x 400	61/2.85	2.0	2.9	68.9	9200	68.8	2.5	3.1	77.4	14160	
Three Cores	3 x 1.5	7/0.53	0.7	1.8	12.0	200	10.3	0.9	1.8	15.7	477
	3 x 2.5	7/0.67	0.7	1.8	12.8	245	11.2	0.9	1.8	16.6	544
	3 x 4	7/0.85	0.7	1.8	14.0	315	12.3	0.9	1.8	17.7	641
	3 x 6	7/1.04	0.7	1.8	15.2	400	13.6	1.25	1.8	19.7	867
	3 x 10	7/1.35	0.7	1.8	17.3	500	15.7	1.25	1.8	21.8	1033
	3 x 16	7/1.70	0.7	1.8	19.9	720	18.1	1.25	1.8	24.7	1460
	3 x 25	7/2.14	0.9	1.8	24.1	1060	22.0	1.6	1.8	29.2	2130
	3 x 35	19/1.53	0.9	1.8	27.0	1390	24.9	1.6	1.8	32.1	2600
	3 x 50	19/1.78	1.0	1.8	30.3	1810	28.2	1.6	1.9	35.7	3180
	3 x 70	19/2.14	1.1	1.9	35.0	2540	33.1	2.0	2.1	41.7	4570
	3 x 95	19/2.52	1.1	2.0	39.5	3390	37.4	2.0	2.2	46.2	5690
	3 x 120	37/2.03	1.2	2.1	43.5	4190	41.2	2.0	2.3	50.2	6680
	3 x 150	37/2.25	1.4	2.3	48.3	5140	46.0	2.5	2.5	56.4	8610
	3 x 185	37/2.52	1.6	2.4	53.5	6390	51.0	2.5	2.6	61.6	10220
	3 x 240	61/2.25	1.7	2.6	60.2	8310	57.7	2.5	2.8	68.7	12670
	3 x 300	61/2.52	1.8	2.8	66.4	10290	63.5	2.5	3.0	74.9	15070
3 x 400	61/2.85	2.0	3.0	74.0	12990	70.7	2.5	3.3	82.7	18360	

Cable Type			MAX-FOH				MAX-FOH-SWA				
Constructions			XLPE Insulated, LSHF sheathed				XLPE Insulated, LSHF bedding, Steel wire armoured and LSHF sheathed				
			Unarmoured				Armoured				
Material Composition			Copper/MGT/XLPE/LSHF				Copper/MGT/XLPE/LSHF/SWA/LSHF				
Standard			IEC 60502-1				IEC 60502-1, BS 7846				
Voltage			600/1000V				600/1000V				
			Unarmoured				Armoured				
	Conductor cross sectional area	No & diameter Of wire	Insulation thickness	Sheath thickness	Cable overall diameter	Cable weight	Diameter under armour	Armour wire diameter	Sheath thickness	Cable overall diameter	Cable weight
Four Cores	4 x 1.5	7/0.53	0.7	1.8	13.0	230	11.3	0.9	1.8	16.7	532
	4 x 2.5	7/0.67	0.7	1.8	14.0	290	12.3	0.9	1.8	17.7	616
	4 x 4	7/0.85	0.7	1.8	15.2	380	13.6	1.25	1.8	19.7	842
	4 x 6	7/1.04	0.7	1.8	16.6	480	15	1.25	1.8	21.1	990
	4 x 10	7/1.35	0.7	1.8	19.0	640	17.3	1.25	1.8	23.4	1212
	4 x 16	7/1.70	0.7	1.8	22.1	920	20	1.6	1.8	27.3	1890
	4 x 25	7/2.14	0.9	1.8	26.5	1390	24.4	1.6	1.8	31.6	2580
	4 x 35	19/1.53	0.9	1.8	29.7	1770	27.6	1.6	1.9	35.0	3110
	4 x 50	19/1.78	1.0	1.9	33.9	2350	32	2.00	2.1	40.6	4340
	4 x 70	19/2.14	1.1	2.0	38.9	3260	36.8	2.00	2.2	45.6	5520
	4 x 95	19/2.52	1.1	2.2	44.1	4490	41.6	2.00	2.3	50.6	7000
	4 x 120	37/2.03	1.2	2.3	48.5	5470	46.2	2.5	2.5	56.6	8940
	4 x 150	37/2.25	1.4	2.4	53.6	6790	51.1	2.5	2.7	61.9	10650
	4 x 185	37/2.52	1.6	2.6	59.7	8400	57.2	2.5	2.8	68.2	12700
	4 x 240	61/2.25	1.7	2.8	67.1	10870	64.2	2.5	3.0	75.6	15710
	4 x 300	61.2.52	1.8	3.0	74.0	13500	70.7	2.5	3.2	82.5	18820
4 x 400	61/2.85	2.0	3.3	82.7	17060	79.2	3.2	3.5	92.9	24420	
Five Cores	5 x 1.5	7/0.53	0.7	1.8	14.0	240	12.4	0.9	1.8	17.8	568
	5 x 2.5	7/0.67	0.7	1.8	15.2	310	13.6	1.25	1.8	19.7	773
	5 x 4	7/0.85	0.7	1.8	16.6	400	15.0	1.25	1.8	21.1	906
	5 x 6	7/1.04	0.7	1.8	18.2	520	16.6	1.25	1.8	22.7	1076
	5 x 10	7/1.35	0.7	1.8	20.7	750	19.1	1.6	1.8	25.9	1526
	5 x 16	7/1.70	0.7	1.8	24.3	1180	22.2	1.6	1.8	29.4	2250
	5 x 25	7/2.14	0.9	1.8	29.0	1800	26.9	1.6	1.9	34.3	3100
	5 x 35	19/1.53	0.9	1.8	32.7	2310	30.6	1.6	2.0	38.2	3810
	5 x 50	19/1.78	1.0	2.0	37.5	3130	35.4	2.0	2.1	44.0	5290
	5 x 70	19/2.14	1.1	2.1	43.0	4310	40.7	2.0	2.3	49.7	6800
	5 x 95	19/2.52	1.1	2.3	48.8	5810	46.5	2.5	2.5	56.9	9280
	5 x 120	37/2.03	1.2	2.4	53.6	7140	51.1	2.5	2.6	61.7	10970
	5 x 150	37/2.25	1.4	2.6	59.6	8790	57.1	2.5	2.8	68.1	13090
	5 x 185	37/2.52	1.6	2.8	66.3	10990	63.4	2.5	3.0	74.8	15770

Cable Type		MAX-FOH					MAX-FOH-SWA				
Constructions		XLPE Insulated, LSHF sheathed					XLPE Insulated, LSHF bedding, Steel wire armoured and LSHF sheathed				
		Unarmoured					Armoured				
Material Composition		Copper/MGT/XLPE/LSHF					Copper/MGT/XLPE/LSHF/SWA/LSHF				
Standard		IEC 60502-1					IEC 60502-1, BS 7846				
Voltage		600/1000V					600/1000V				
		Unarmoured					Armoured				
	Conductor cross sectional area	No. & diameter Of wire	Insulation thickness	Sheath thickness	Cable overall diameter	Cable weight	Diameter under armour	Armour wire diameter	Sheath thickness	Cable overall diameter	Cable weight
Multicore – 1.5 mm ²	6 x 1.5	7/0.53	0.7	1.8	15.2	280	13.6	1.25	1.8	19.7	750
	7 x 1.5	7/0.53	0.7	1.8	15.2	295	13.6	1.25	1.8	19.7	765
	10 x 1.5	7/0.53	0.7	1.8	19.0	410	17.4	1.25	1.8	23.5	990
	12 x 1.5	7/0.53	0.7	1.8	19.6	460	18.0	1.25	1.8	24.1	1070
	14 x 1.5	7/0.53	0.7	1.8	20.6	520	19.0	1.6	1.8	25.8	1290
	16 x 1.5	7/0.53	0.7	1.8	21.7	580	20.1	1.6	1.8	26.9	1390
	19 x 1.5	7/0.53	0.7	1.8	22.9	660	21.3	1.6	1.8	28.1	1510
	24 x 1.5	7/0.53	0.7	1.8	26.7	830	25.1	1.6	1.9	32.1	1830
	27 x 1.5	7/0.53	0.7	1.8	27.3	900	25.7	1.6	1.9	32.7	1930
	37 x 1.5	7/0.53	0.7	1.8	30.5	1180	29.3	2.0	2.0	37.3	2640
Multicore – 2.5 mm ²	6 x 2.5	7/0.67	0.7	1.8	16.5	355	14.9	1.25	1.8	21.0	860
	7 x 2.5	7/0.67	0.7	1.8	16.5	380	14.9	1.25	1.8	21.0	890
	10 x 2.5	7/0.67	0.7	1.8	20.7	530	19.1	1.6	1.8	25.9	1300
	12 x 2.5	7/0.67	0.7	1.8	21.4	610	19.8	1.6	1.8	26.6	1400
	14 x 2.5	7/0.67	0.7	1.8	22.4	686	20.8	1.6	1.8	27.6	1510
	16 x 2.5	7/0.67	0.7	1.8	23.7	770	21.1	1.6	1.8	28.9	1650
	19 x 2.5	7/0.67	0.7	1.8	25.0	880	23.4	1.6	1.8	30.2	1800
	24 x 2.5	7/0.67	0.7	1.8	29.2	1100	27.6	1.6	1.9	34.6	2200
	27 x 2.5	7/0.67	0.7	1.8	29.8	1210	28.2	1.6	1.9	35.2	2330
	37 x 2.5	7/0.67	0.7	1.9	33.7	1610	32.3	2.0	2.1	40.5	3220

No. of core and nominal cross section	Conductor construction		MAX-FOH-125 (Un-Armoured)						MAX-FOH-125 (Armoured)							Maximum conductor resistance @ 20°C		
			Nominal insulation thickness	Nominal insulation diameter	Nominal sheath thickness	Approx. outer diameter	Tolerance OD	Approx. weight	Nominal diameter over bedding	Nominal diameter of armour wires	Nominal diameter over armour	Nominal sheath thickness	Approx. outer diameter	Tolerance OD	Approx. weight			
			(mm)	(mm)	(mm)	(mm)	(mm)	(kg/km)	(mm)	(mm)	(mm)	(mm)	(mm)	(mm)	(kg/km)	Cu (Ω/km)	TiCu (Ω/km)	
1 X 1.5	7	0.53	0.7	3.8	1.4	6.8	0.5	69	-	-	-	-	-	-	-	-	12.10	12.20
1 X 2.5	7	0.67	0.7	4.2	1.4	7.2	0.5	83	-	-	-	-	-	-	-	-	7.41	7.56
1 X 4	7	0.85	0.7	4.8	1.4	7.8	0.5	103	-	-	-	-	-	-	-	-	4.61	4.70
1 X 6	7	1.04	0.7	5.3	1.4	8.3	0.5	128	-	-	-	-	-	-	-	-	3.08	3.11
1 X 10	7	1.35	0.7	6.2	1.4	9.2	0.5	175	-	-	-	-	-	-	-	-	1.83	1.84
1 X 16	7	1.70	0.7	7.3	1.4	10.3	1.0	241	-	-	-	-	-	-	-	-	1.15	1.16
1 X 25	7	2.14	0.7	9.0	1.4	12.0	1.0	352	-	-	-	-	-	-	-	-	0.727	0.734
1 X 35	19	1.53	0.9	10.3	1.4	13.3	1.0	454	-	-	-	-	-	-	-	-	0.524	0.529
1 X 50	19	1.78	1.0	11.8	1.4	14.8	1.0	594	13.8	1.6	17.2	1.5	20.7	1.5	870	0.387	0.391	
1 X 70	19	2.14	1.1	13.7	1.4	16.7	1.0	806	15.7	1.6	19.1	1.6	22.8	1.5	1127	0.268	0.270	
1 X 95	19	2.52	1.1	15.7	1.5	18.9	1.0	1083	17.7	1.6	21.1	1.6	24.8	1.5	1427	0.193	0.195	
1 X 120	37	2.03	1.2	17.4	1.5	20.9	1.5	1320	19.4	1.6	22.8	1.7	26.7	1.5	1705	0.153	0.154	
1 X 150	37	2.25	1.4	19.4	1.6	23.1	1.5	1631	21.4	1.6	24.8	1.7	28.7	1.5	2042	0.124	0.126	
1 X 185	37	2.52	1.6	21.7	1.7	25.6	1.5	2031	23.7	1.6	27.3	1.8	31.4	2.0	2496	0.0991	0.1000	
1 X 240	61	2.25	1.7	24.5	1.7	28.4	1.5	2599	26.5	1.6	30.2	1.9	34.5	2.0	3128	0.0754	0.0762	
1 X 300	61	2.52	1.8	27.2	1.8	31.3	2.0	3218	29.2	1.6	32.8	2.0	37.3	2.0	3796	0.0601	0.0607	
1 X 400	61	2.85	2.0	30.4	1.9	34.7	2.0	4050	32.8	2.0	37.3	2.1	42.0	2.5	4834	0.0470	0.0475	
1 X 500	61	3.20	2.2	34.1	2.1	38.8	2.0	5112	36.5	2.0	40.9	2.2	45.8	2.5	5952	0.0366	0.0384	
1 X 630	127	2.52	2.4	38.3	2.2	43.2	2.5	6481	40.7	2.0	45.2	2.3	50.3	3.0	7417	0.0283	0.0286	
2 X 1.5	7	0.53	0.7	3.8	1.8	11.4	1.0	190	9.6	0.9	11.3	1.8	15.1	1.0	440	12.10	12.20	
2 X 2.5	7	0.67	0.7	4.2	1.8	12.2	1.0	229	10.4	0.9	12.2	1.8	16.0	1.0	501	7.41	7.56	
2 X 4	7	0.85	0.7	4.8	1.8	13.3	1.0	284	11.5	0.9	13.2	1.8	17.0	1.0	581	4.61	4.70	
2 X 6	7	1.04	0.7	5.3	1.8	14.4	1.0	355	12.6	0.9	14.4	1.8	18.2	1.0	677	3.08	3.11	
2 X 10	7	1.35	0.7	6.2	1.8	16.4	1.0	393	14.6	1.25	17.1	1.8	21.2	1.5	877	1.83	1.84	
2 X 16	7	1.70	0.7	7.3	1.8	18.6	1.0	544	16.8	1.25	19.2	1.8	23.3	1.5	1097	1.15	1.16	
2 X 25	7	2.14	0.9	9.0	1.8	22.4	1.5	806	20.3	1.6	23.4	1.8	27.5	1.5	1600	0.727	0.734	
2 X 35	19	1.53	0.9	10.3	1.8	25.1	1.5	1023	23.0	1.6	26.1	1.8	30.2	2.0	1910	0.524	0.529	
2 X 50	19	1.78	1.0	11.8	1.8	28.2	1.5	1373	26.1	1.6	29.2	1.9	33.5	2.0	2387	0.387	0.391	
2 X 70	19	2.14	1.1	13.7	1.8	32.1	2.0	1816	30.0	1.6	33.5	2.0	38.0	2.0	3013	0.268	0.270	
2 X 95	19	2.52	1.1	15.7	2.0	36.6	2.0	2481	34.5	2.0	38.9	2.1	43.6	2.5	4181	0.193	0.195	
2 X 120	37	2.03	1.2	17.4	2.1	40.3	2.5	2999	38.0	2.0	42.3	2.2	47.2	2.5	4880	0.153	0.154	
2 X 150	37	2.25	1.4	19.4	2.2	44.5	2.5	3709	42.0	2.0	46.4	2.4	51.7	3.0	5802	0.124	0.126	
2 X 185	37	2.52	1.6	21.7	2.3	49.4	2.5	4602	47.1	2.5	52.4	2.5	57.9	3.0	7467	0.0991	0.1000	
2 X 240	61	2.25	1.7	24.5	2.5	55.5	3.0	5957	52.8	2.5	58.2	2.7	64.1	3.5	9161	0.0754	0.0762	
2 X 300	61	2.52	1.8	27.2	2.6	61	3.5	7309	58.5	2.5	63.9	2.9	70.2	3.5	10942	0.0601	0.0607	
2 X 400	61	2.85	2.0	30.4	2.9	68.2	3.5	9245	65.1	2.5	70.5	3.1	77.2	3.5	13239	0.0470	0.0475	
3 X 1.5	7	0.53	0.7	3.8	1.8	12.0	1.0	219	10.2	0.9	11.9	1.8	15.7	1.0	490	12.10	12.20	
3 X 2.5	7	0.67	0.7	4.2	1.8	12.9	1.0	268	11.1	0.9	12.9	1.8	16.7	1.0	558	7.41	7.56	
3 X 4	7	0.85	0.7	4.8	1.8	14.1	1.0	338	12.3	0.9	14.0	1.8	17.8	1.0	654	4.61	4.70	
3 X 6	7	1.04	0.7	5.3	1.8	15.3	1.0	427	13.5	1.25	15.9	1.8	19.7	1.0	876	3.08	3.11	
3 X 10	7	1.35	0.7	6.2	1.8	17.4	1.0	520	15.6	1.25	18.1	1.8	22.2	1.5	1039	1.83	1.84	
3 X 16	7	1.70	0.7	7.3	1.8	19.8	1.0	722	18	1.25	20.4	1.8	24.5	1.5	1310	1.15	1.16	
3 X 25	7	2.14	0.9	9.0	1.8	23.9	1.5	1073	21.8	1.6	24.9	1.8	29	1.5	1922	0.727	0.734	
3 X 35	19	1.53	0.9	10.3	1.8	26.8	1.5	1400	24.7	1.6	27.8	1.8	31.9	2.0	2343	0.524	0.529	
3 X 50	19	1.78	1.0	11.8	1.8	30.1	2.0	1830	28	1.6	31.5	1.9	35.8	2.0	2932	0.387	0.391	
3 X 70	19	2.14	1.1	13.7	1.9	34.7	2.0	2555	32.8	2.0	37.2	2.1	41.9	2.5	4209	0.268	0.270	
3 X 95	19	2.52	1.1	15.7	2.0	39.2	2.0	3399	37.1	2.0	41.4	2.2	46.3	2.5	5242	0.193	0.195	
3 X 120	37	2.03	1.2	17.4	2.1	43.1	2.5	4237	40.8	2.0	45.2	2.3	50.3	3.0	6265	0.153	0.154	
3 X 150	37	2.25	1.4	19.4	2.3	47.9	2.5	5210	45.6	2.5	50.9	2.5	56.4	3.0	7983	0.124	0.126	
3 X 185	37	2.52	1.6	21.7	2.4	53.1	3.0	6519	50.6	2.5	55.9	2.6	61.6	3.5	9579	0.0991	0.1000	
3 X 240	61	2.25	1.7	24.5	2.6	59.7	3.0	8339	57.2	2.5	62.5	2.8	68.6	3.5	11844	0.0754	0.0762	
3 X 300	61	2.52	1.8	27.2	2.8	65.8	3.5	10358	62.9	2.5	68.3	3.0	74.8	3.5	14207	0.0601	0.0607	
3 X 400	61	2.85	2.0	30.4	3.0	73.4	3.5	13071	70.1	2.5	75.4	3.3	82.5	4.1	17399	0.0470	0.0475	

No. of core and nominal cross section	Conductor construction		MAX-FOH-125 (Un-Armoured)							MAX-FOH-125 (Armoured)							Maximum conductor resistance @ 20°C	
			Nominal insulation thickness	Nominal insulation diameter	Nominal sheath thickness	Approx. outer diameter	Tolerance OD	Approx. weight	Nominal diameter over bedding	Nominal diameter of armour wires	Nominal diameter over armour	Nominal sheath thickness	Approx. outer diameter	Tolerance OD	Approx. weight			
			(mm)	(mm)	(mm)	(mm)	(mm)	(kg/km)	(mm)	(mm)	(mm)	(mm)	(mm)	(mm)	(kg/km)	Cu (Ω/km)	TinCu (Ω/km)	
4 X 1.5	7	0.53	0.7	3.8	1.8	13.0	1.0	259	11.2	0.9	12.9	1.8	16.7	1.0	550	12.10	12.20	
4 X 2.5	7	0.67	0.7	4.2	1.8	14.0	1.0	319	12.2	0.9	14.0	1.8	17.8	1.0	635	7.41	7.56	
4 X 4	7	0.85	0.7	4.8	1.8	15.3	1.0	408	13.5	1.25	15.9	1.8	19.7	1.0	856	4.61	4.70	
4 X 6	7	1.04	0.7	5.3	1.8	16.7	1.0	520	14.9	1.25	17.3	1.8	21.4	1.5	1014	3.08	3.11	
4 X 10	7	1.35	0.7	6.2	1.8	19.1	1.0	678	17.3	1.25	19.7	1.8	23.8	1.5	1243	1.83	1.84	
4 X 16	7	1.70	0.7	7.3	1.8	22.0	1.5	927	19.9	1.6	23.0	1.8	27.1	1.5	1697	1.15	1.16	
4 X 25	7	2.14	0.9	9.0	1.8	26.2	1.5	1401	24.1	1.6	27.3	1.8	31.4	2.0	2325	0.727	0.734	
4 X 35	19	1.53	0.9	10.3	1.8	29.5	1.5	1794	27.4	1.6	30.9	1.9	35.2	2.0	2877	0.524	0.529	
4 X 50	19	1.78	1.0	11.8	1.9	33.4	2.0	2403	31.5	2.0	35.8	2.1	40.5	2.5	3995	0.387	0.391	
4 X 70	19	2.14	1.1	13.7	2.0	38.5	2.0	3298	36.4	2.0	40.8	2.2	45.7	2.5	5111	0.268	0.270	
4 X 95	19	2.52	1.1	15.7	2.2	43.7	2.5	4502	41.2	2.0	45.6	2.3	50.7	3.0	6537	0.193	0.195	
4 X 120	37	2.03	1.2	17.4	2.3	48.1	2.5	5495	45.8	2.5	51.1	2.5	56.6	3.0	8309	0.153	0.154	
4 X 150	37	2.25	1.4	19.4	2.4	53.2	3.0	6894	50.7	2.5	56.0	2.7	61.9	3.5	10026	0.124	0.126	
4 X 185	37	2.52	1.6	21.7	2.6	59.2	3.0	8539	56.7	2.5	62.0	2.8	68.1	3.5	12039	0.0991	0.1000	
4 X 240	61	2.25	1.7	24.5	2.8	66.5	3.5	11076	63.6	2.5	69.0	3.0	75.5	3.5	14971	0.0754	0.0762	
4 X 300	61	2.52	1.8	27.2	3.0	73.3	3.5	13632	70.0	2.5	75.4	3.2	82.3	4.1	17918	0.0601	0.0607	
4 X 400	61	2.85	2.0	30.4	3.3	82.0	4.1	17280	78.5	3.15	85.1	3.5	92.6	4.6	23179	0.0470	0.0475	
5 X 1.5	7	0.53	0.7	3.8	1.8	14.2	1.0	267	12.4	0.9	14.1	1.8	17.9	1.0	583	12.10	12.20	
5 X 2.5	7	0.67	0.7	4.2	1.8	15.3	1.0	333	13.5	1.25	15.9	1.8	19.7	1.0	782	7.41	7.56	
5 X 4	7	0.85	0.7	4.8	1.8	16.7	1.0	428	14.9	1.25	17.4	1.8	21.5	1.5	923	4.61	4.70	
5 X 6	7	1.04	0.7	5.3	1.8	18.3	1.0	550	16.5	1.25	18.9	1.8	23.0	1.5	1090	3.08	3.11	
5 X 10	7	1.35	0.7	6.2	1.8	21.1	1.5	814	19.0	1.6	22.1	1.8	26.2	1.5	1548	1.83	1.84	
5 X 16	7	1.70	0.7	7.3	1.8	24.1	1.5	1162	22.0	1.6	25.1	1.8	29.2	1.5	2012	1.15	1.16	
5 X 25	7	2.14	0.9	9.0	1.8	28.8	1.5	1703	26.7	1.6	29.8	1.9	34.1	2.0	2736	0.727	0.734	
5 X 35	19	1.53	0.9	10.3	1.8	32.4	2.0	2236	30.3	1.6	33.9	2.0	38.4	2.0	3469	0.524	0.529	
5 X 50	19	1.78	1.0	11.8	2.0	37.1	2.0	3003	35.0	2.0	39.4	2.2	44.3	2.5	4754	0.387	0.391	
5 X 70	19	2.14	1.1	13.7	2.1	42.6	2.5	4124	40.3	2.0	44.7	2.3	49.8	2.5	6124	0.268	0.270	
5 X 95	19	2.52	1.1	15.7	2.3	48.3	2.5	5628	46.0	2.5	51.4	2.5	56.9	3.0	8445	0.193	0.195	
5 X 120	37	2.03	1.2	17.4	2.4	53.2	3.0	6890	50.7	2.5	56	2.7	61.9	3.5	10022	0.153	0.154	
5 X 150	37	2.25	1.4	19.4	2.6	59.1	3.0	8511	56.6	2.5	61.9	2.8	68.0	3.5	12010	0.124	0.126	
5 X 185	37	2.52	1.6	21.7	2.8	65.7	3.5	10725	62.8	2.5	68.1	3.0	74.6	3.5	14572	0.0991	0.1000	
5 X 240	61	2.25	1.7	24.5	3.0	73.9	3.5	13732	70.6	2.5	75.9	3.2	82.8	4.1	18023	0.0754	0.0762	
6 X 1.5	7	0.53	0.7	3.8	1.8	15.3	1.0	311	13.5	1.25	15.9	1.8	19.7	1.0	760	12.10	12.20	
7 X 1.5	7	0.53	0.7	3.8	1.8	15.3	1.0	332	13.5	1.25	15.9	1.8	19.7	1.0	781	12.10	12.20	
10 X 1.5	7	0.53	0.7	3.8	1.8	19.1	1.0	462	17.3	1.25	19.7	1.8	23.8	1.5	1026	12.10	12.20	
12 X 1.5	7	0.53	0.7	3.8	1.8	19.7	1.0	525	17.9	1.25	20.4	1.8	24.5	1.5	1111	12.10	12.20	
14 X 1.5	7	0.53	0.7	3.8	1.8	21.0	1.5	590	18.9	1.25	21.3	1.8	25.4	1.5	1200	12.10	12.20	
16 X 1.5	7	0.53	0.7	3.8	1.8	22.1	1.5	662	20.0	1.6	23.1	1.8	27.2	1.5	1431	12.10	12.20	
19 X 1.5	7	0.53	0.7	3.8	1.8	23.2	1.5	756	21.1	1.6	24.2	1.8	28.3	1.5	1569	12.10	12.20	
24 X 1.5	7	0.53	0.7	3.8	1.8	27.0	1.5	945	24.9	1.6	28.0	1.8	32.1	2.0	1903	12.10	12.20	
27 X 1.5	7	0.53	0.7	3.8	1.8	27.6	1.5	1037	25.5	1.6	28.6	1.8	32.7	2.0	2013	12.10	12.20	
37 X 1.5	7	0.53	0.7	3.8	1.8	30.8	2.0	1356	28.7	1.6	31.8	1.9	36.1	2.0	2462	12.10	12.20	
6 X 2.5	7	0.67	0.7	4.2	1.8	16.6	1.0	388	14.8	1.25	17.2	1.8	21.3	1.5	881	7.41	7.56	
7 X 2.5	7	0.67	0.7	4.2	1.8	16.6	1.0	420	14.8	1.25	17.2	1.8	21.3	1.5	913	7.41	7.56	
10 X 2.5	7	0.67	0.7	4.2	1.8	21.1	1.5	588	19.0	1.6	22.1	1.8	26.2	1.5	1321	7.41	7.56	
12 X 2.5	7	0.67	0.7	4.2	1.8	21.8	1.5	671	19.7	1.6	22.8	1.8	26.9	1.5	1438	7.41	7.56	
14 X 2.5	7	0.67	0.7	4.2	1.8	22.8	1.5	758	20.7	1.6	23.8	1.8	27.9	1.5	1569	7.41	7.56	
16 X 2.5	7	0.67	0.7	4.2	1.8	24.0	1.5	854	21.9	1.6	25.1	1.8	29.2	1.5	1702	7.41	7.56	
19 X 2.5	7	0.67	0.7	4.2	1.8	25.3	1.5	981	23.2	1.6	26.3	1.8	30.4	2.0	1867	7.41	7.56	
24 X 2.5	7	0.67	0.7	4.2	1.8	29.5	1.5	1230	27.4	1.6	30.5	1.9	34.8	2.0	2281	7.41	7.56	
27 X 2.5	7	0.67	0.7	4.2	1.8	30.2	2.0	1352	28.1	1.6	31.2	1.9	35.5	2.0	2438	7.41	7.56	
37 X 2.5	7	0.67	0.7	4.2	1.9	33.9	2.0	1799	32.0	2.0	36.0	2.1	40.7	2.5	3360	7.41	7.56	

SELECTION OF CROSS-SECTIONAL AREA OF CONDUCTOR



In order to choose the right power cable, one has to consider:

- the current
- the voltage drop
- the short circuit rating
- the installation methods
- the ambient temperature
- the frequency and harmonic current
- maximum safe length at short circuit

Current Rating

When electric current flows through the conductor of a cable, the electrical resistance of the conductor generates heat. When a temperature greater than that allowed is reached by the cable due to heat generation, a larger conductor size (with lower electrical resistance) has to be selected. Other important considerations are methods of installation of the cable and ambient temperature. Calculation which takes into account all criteria are described in EIT standard 2001-56 and are rather complex. In general, preference is given to standard current rating tables which are issued by national standardization bureaus. The current rating are based on the following standard conditions of the installation.

1. Maximum operating temperature of conductor = 90°C, 110-125°C
2. Ambient air temperature = 40°C
3. Ground temperature = 30°C

Voltage Drop

Another important factor for the determination of the conductor size is the voltage drop. The voltage drop of the cable at a given current is caused by losses in the cable. In case of a too high voltage drop, it is necessary to choose a bigger conductor size. The voltage drop in a cable denotes the difference in voltage at the beginning and at the end of the cable. It depends on:

- the current carried
- the power factor
- the length of the cable
- the resistance of the cable
- reactance of the cable

The permissible voltage drop is usually stated as a percentage of the circuit voltage.

According to EIT standard 2001-56 regulation, it is stipulated that the total voltage drop for any particular cable run must be such that the voltage drop in the circuit of which the cable forms a part does not exceed 5% of the nominal voltage of the supply.

Selection of Cable based On Voltage Drop and Current using tables

Since the actual power factor of the load is usually not known, the most practical approach to the question of the voltage drop is to assume the worst conditions, i.e. power factor equal to one and the conductor is at maximum operating temperature. The voltage drop values given in the tables are based on these assumptions.

The values of the voltage drop (Vd) are tabulated for a current of one Ampere for a 1 metre run, the value of voltage drop needs to be multiplied by the length of the run, in metre, and by the current, in Ampere that the cables are to carry.

$$V = Vd \times I \times L$$

Where V = Voltage
 Vd = Approximate Voltage drop/Ampere/metre
 I = Current in Ampere per phase
 L = Route length in metres

Examples:

Given that the supply voltage is 400V, 3 phase 50Hz and that the cable used is a 4C Cu/mica/XLPE/SWA/LSHF fire resistant cable. Required cable is to be installed in aground and to carry a 250 Amp load per phase over a route length of 100 m. Cable installation is to be in compliance with EIT standard 2001-56 regulation.

$$V = Vd \times I \times L$$

Maximum permissible voltage drop
 Vmax = 5% of 400V
 Vmax = 20.0V

Voltage drop/ampere/metre

$$Vd = \frac{V_{max}}{I \times L} = \frac{20.0}{250 \times 100} = 0.80mV$$

Selected from Table 3-4 (หน้า 54) such that the Vd value is equal to, or less than calculated 0.80mV, at the same time ensuring that it will carry the current. It will be seen that this table value shall be 0.60mV giving a cable size of 70 mm².

Minimum bending radius

Type of cable	Unarmoured		Armoured	
	Number of cores	Single core		Multicore
600/1000V		8D	6D	10D

Where D: diameter of cable

Side wall pressure to cable

Permissible maximum side wall pressure to the cable at bending during installation is 500 kgf/m.

$$\begin{aligned} \text{Side wall pressure to cable} &= \frac{\text{Pulling tension (kgf)}}{\text{Bending radius (m)}} \\ &= \frac{T}{R} \end{aligned}$$

Permissible maximum pulling tension (T)

Conductor	Tension (kgf)
copper	7 x (No. of cores) x (cross-sectional area of conductor)

Drum handling

Handle the drums with care! It is always recommended and a must with heavy drums – to lift drums with a fork-lift truck or a crane when removing them from the vehicle. Always take care to lower the drums into an upright position on their flanges

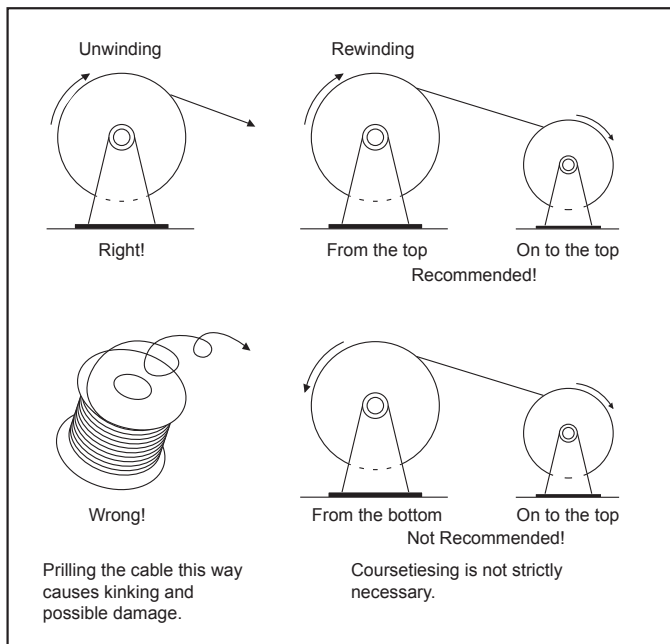

ZERTIFIKAT • CERTIFICATE • CERTIFICADO • CERTIFICATO • CERTIFICATE • CERTIFICATE



Product Service

CERTIFICATE

No. B 15 03 91277 004

Holder of Certificate: MCI-Draka Cable Co.,Ltd
2/7 Moo 2, Banbung-Bankhai rd.
km 57 Nongbua,
Banbu
Rayong 21120
THAILAND
91277

Production Facility(ies): 91277

Certification Mark: 



Product: Fire Resistant Cables
Model(s): MAX FOH(i)
Parameters: Type : CU/MGT/XLPEV Cable
Size : 1C x 1.5mm² to 1C x 630mm²
Voltage : 600/1000V
See appendix for details cable construction

Tested according to: BS 6387:2013
SS 299-1:1998/A1:2008
IEC 61034-2(ed.3)
IEC 60331-21(ed.1)
IEC 60332-1-2(ed.1)
IEC 60332-3-22(ed.1.1)
IEC 60332-3-23(ed.1.1)
IEC 60332-3-24(ed.1.1)
IEC 60754-1(ed.3)
IEC 60754-2(ed.2)

The product was tested on a voluntary basis and complies with the essential requirements. The certification mark shown above can be affixed on the product. It is not permitted to alter the certification mark in any way. In addition the certification holder must not transfer the certificate to third parties. See also notes overleaf.

Test report no.: 7191089325-EEC14 See Attached
Valid until: 2020-03-02

Date, 2015-03-03
Page 1 of 2 (Kim Suah Phua)

TÜV SÜD Product Service GmbH • Zertifikatsstelle • Ridelstraße 65 • 80339 München • Germany TÜV®

ZERTIFIKAT • CERTIFICATE • CERTIFICADO • CERTIFICATO • CERTIFICATE • CERTIFICATE

Product Service

CERTIFICATE

No. B 15 03 91277 003

Holder of Certificate: MCI-Draka Cable Co.,Ltd
2/7 Moo 2, Banbung-Bankhai rd.
km 57 Nongbua,
Banbu
Rayong 21120
THAILAND
91277

Production Facility(ies): 91277

Certification Mark: 

Product: Fire Resistant Cables
Model(s): MAX FOH
Parameters: Type : CU/MGT/XLPE/LSHF Cable
Size : 1C x 1.5mm² to 1C x 630mm²
Voltage : 600/1000V
See appendix for details cable construction

Tested according to: BS 6387:2013
SS 299-1:1998/A1:2008
IEC 61034-2(ed.3)
IEC 60331-21(ed.1)
IEC 60332-1-2(ed.1)
IEC 60332-3-22(ed.1.1)
IEC 60332-3-23(ed.1.1)
IEC 60332-3-24(ed.1.1)
IEC 60754-1(ed.3)
IEC 60754-2(ed.2)

The product was tested on a voluntary basis and complies with the essential requirements. The certification mark shown above can be affixed on the product. It is not permitted to alter the certification mark in any way. In addition the certification holder must not transfer the certificate to third parties. See also notes overleaf.

Test report no.: 7191089325-EEC14 See Attached
Valid until: 2020-03-02

Date, 2015-03-03
Page 1 of 2 (Kim Suah Phua)



TÜV SÜD Product Service GmbH • Zertifikatsstelle • Ridelstraße 65 • 80339 München • Germany TÜV®

ZERTIFIKAT • CERTIFICATE • CERTIFICADO • CERTIFICATO • CERTIFICATE • CERTIFICATE

PSB Singapore

CERTIFICATE OF CONFORMITY

No. CLS1A 13 12 80496 013

Certificate Holder: Singapore Cables Manufacturers Pte Ltd
No.20 Jurong Port Road
Singapore 619094
SINGAPORE

Certification Mark: 

Product: Fire Resistant Cables
Brand Name: DRAKA
Model(s): 1) FIRETUF CLASSIC MI SIFER (x)
2) MAX-FOH-125

Product Details: Voltage: 600/1000V
Conductor: Circular stranded plain copper wire
Fire resistant layer: Mica tape
Insulation: XL110 (XLPEVA) cross linked low smoke halogen free compound
Sheathing: LSHF compound
Sizes: 1C x 1.5mm² to 1C x 630mm²

Standard(s): BS 6387:1994
Country of Origin: Malaysia
Test Report(s): See COC Appendix (1 pg)
Issued on: 2014-01-23
Valid until: 2017-01-12

Products listed under Class 1A must have TÜV SÜD PSB PLS mark as shown above affixed/printed on them. Failure to comply with this requirement may result in revocation of the certificate.

Vice-President (Certification Department)
TUV SUD PSB

TÜV SÜD PSB Pte Ltd • 1 Science Park Drive • Singapore 118221 TÜV®

ZERTIFIKAT • CERTIFICATE • CERTIFICADO • CERTIFICATO • CERTIFICATE • CERTIFICATE

PSB Singapore

CERTIFICATE OF CONFORMITY

No. CLS1A 14 09 80496 020

Certificate Holder: Singapore Cables Manufacturers Pte Ltd
No.20 Jurong Port Road
Singapore 619094
SINGAPORE

Certification Mark: 

Product: Fire Resistant Cables
Brand Name: DRAKA
Model(s): MAX-FOH
Product Details: Voltage: 300/500V
Conductor: Stranded circular plain copper wires
Fire resistant layer: Mica tape
Insulation: XLPE
Sheath: LSHF
Sizes: 2C x 1.5mm² to 4C x 4.0mm²

Standard(s): BS 6387:2013
SS 299-1/A1:2008
IEC 60332-1-2:2004
IEC 60332-3-22:2009
IEC 60332-3-24:2009
IEC 61034-2:2005
IEC 60754-2:2011

Country of Origin: Malaysia
Test Report(s): See CoC Appendix (1 pg)
Issued on: 2014-09-09
Valid until: 2017-09-08

Products listed under Class 1A must have TÜV SÜD PSB PLS mark as shown above affixed/printed on them. Failure to comply with this requirement may result in revocation of the certificate.

Vice-President (Certification Department)
TUV SUD PSB

TÜV SÜD PSB Pte Ltd • 1 Science Park Drive • Singapore 118221 TÜV®

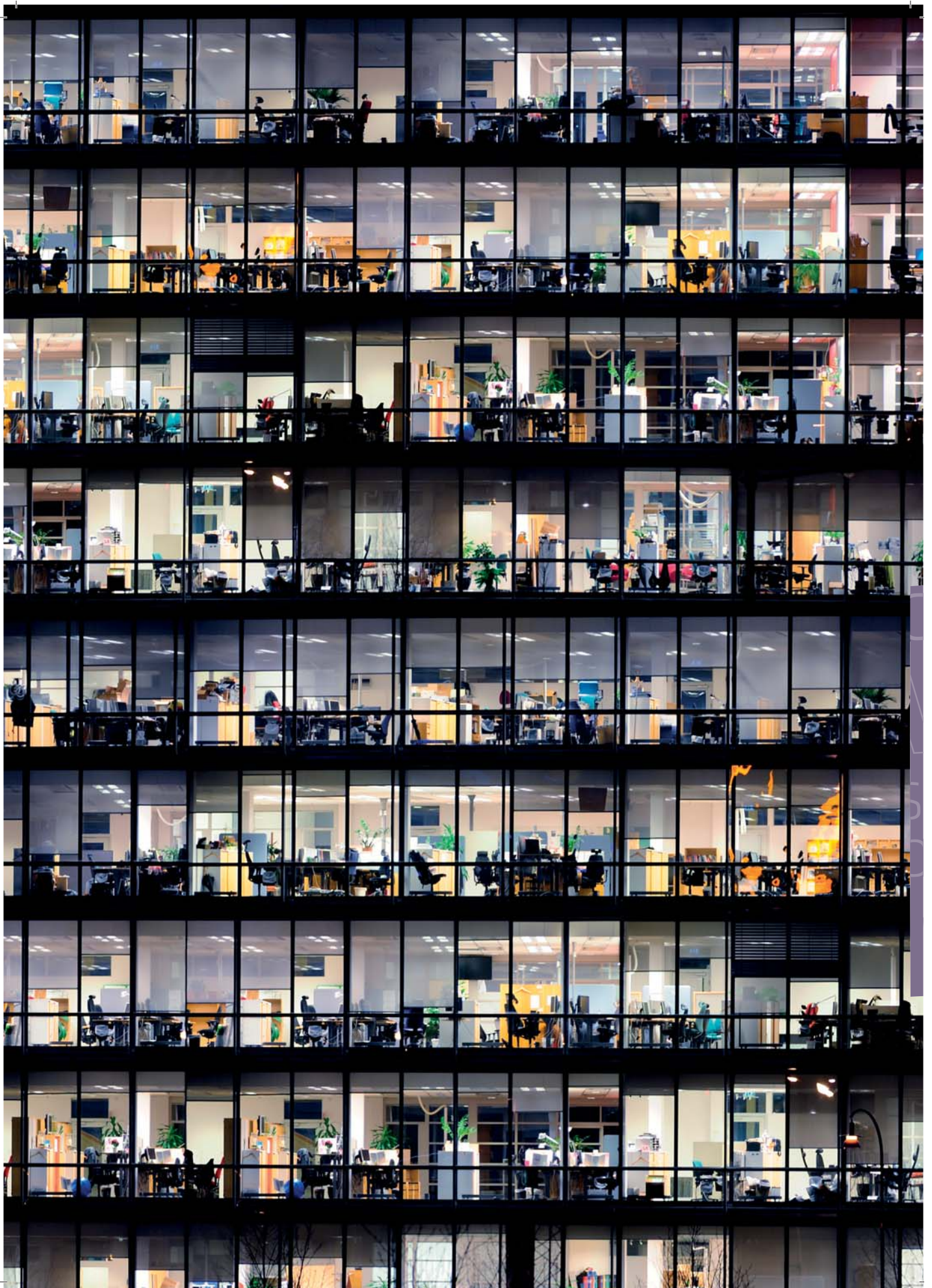



LSHF: LOW SMOKE HALOGEN-FREE CABLES

CE EXTENDED PRODUCT OFFER
WORLDWIDE LEA
SUPPORTING GLOBAL UTILITIES IN THE D
OF SMARTER AND GREENER POWER GR
STRONGER PLATFORM

LOW SMOKE HALOGEN FREE CABLES

In certain applications, cables under fire conditions have become a major concern. When conventional cables burn, they may emit smoke, halogen and toxic gases that may obscure vision and may be harmful to both equipment and human beings.

After years of research and development, Prsymian Group is manufacturing and supplying Low Smoke Halogen Free Cables which meets the severe requirements of cables under fire condition.

Unlike conventional cables, Low Smoke Halogen Free Cables have the following characteristics: -

1. **Low Smoke** : When the cable is on fire, it does not liberate large volume of dense black smoke. These cables when ignited will only produce a limited amount of smoke. This property helps to improve safety in areas where there are limited means to escape in the event of an emergency, or where large crowds are regularly in attendance.
2. **Halogen Free** : When the cable is on fire, it does not emit any halogen gases. These are acidic and will attack equipment and human beings. The property helps to protect computer, electronic/ communication equipment and reduces thee toxicity of thee gases emitted from the fire. This reduces the risk of personnel engaged in vital operations being incapacitated and the safe escape of people in an emergency.

With the superior fire performance, these range of cables are recommended for use in the following areas:

1. Underground tunnels, lifts, power stations
2. Mass Rapid Transit System
3. Airports
4. Large buildings/Multi Story Buildings
5. Critical areas of an installations e.g. escape route of an installation
6. Oil Platforms/Ships
7. Areas where masses of people gather and areas with limited means of escape in the event of a fire
8. Military installations/equipment/machines
9. Critical circuits that must continue to operate in case of a fire. e.g. Fire alarms, emergency lifts, pumps circuits etc.

CHARACTERISTICS OF LOW SMOKE HALOGEN FREE CABLES

Applicable test methods/standards for Low Smoke Halogen Free Property

Performance in Fire Tests

Fire Propagation	Acid Gas																																
<table border="0"> <tr><td>IEC 60332 PART 3</td><td>(International)</td></tr> <tr><td>BS 4066 PART 3</td><td>(UK)</td></tr> <tr><td>CEI 20-22</td><td>(Italy)</td></tr> <tr><td>VDE 804C</td><td>(Germany)</td></tr> <tr><td>NF C 32-070 CAT. C1</td><td>(France)</td></tr> <tr><td>IEEE 383</td><td>(USA)</td></tr> <tr><td>UL 1581</td><td>(USA)</td></tr> <tr><td>UL 1666</td><td>(USA)</td></tr> <tr><td>FT4</td><td>(Canada)</td></tr> <tr><td>AS 1660.5.1</td><td>(Australia)</td></tr> </table> <p>Cables jacketed with polyethylene or certain types of PVC compounds have the potential to spread or propagate a fire along a cable run. Many international bodies have devised tests designed to assess this property. LSHF Cables are flame retardant and hence both hard to ignite and only burn with difficulty. Cables jacketed with LSHF compounds have consistently been found to comply with most of these needs.</p>	IEC 60332 PART 3	(International)	BS 4066 PART 3	(UK)	CEI 20-22	(Italy)	VDE 804C	(Germany)	NF C 32-070 CAT. C1	(France)	IEEE 383	(USA)	UL 1581	(USA)	UL 1666	(USA)	FT4	(Canada)	AS 1660.5.1	(Australia)	<table border="0"> <tr><td>IEC 60754 PART 1</td><td>(International)</td></tr> <tr><td>IEC 60754 PART 2</td><td>(International)</td></tr> <tr><td>CEI 20-37 PART 1</td><td>(Italy)</td></tr> <tr><td>VDE 0472 PART 813</td><td>(Germany)</td></tr> <tr><td>NF C 20-453</td><td>(France)</td></tr> <tr><td>AS 1660.5.4</td><td>(Australia)</td></tr> </table> <p>Many flame retardant compounds are based on halogen containing chemicals. Halogen can be present as part of the polymer e.g. PVC or may be a component of a flame retardant additive. When burnt, these materials liberate acidic gases such as hydrochloric gas which, when in contact with electrical or electronic components, can cause very expensive corrosion damage. The cost of these secondary damage can far exceed those attributed to flame damage, particularly when associated with computer and communication equipment. LSHF Cables are designed not to release acidic gases.</p>	IEC 60754 PART 1	(International)	IEC 60754 PART 2	(International)	CEI 20-37 PART 1	(Italy)	VDE 0472 PART 813	(Germany)	NF C 20-453	(France)	AS 1660.5.4	(Australia)
IEC 60332 PART 3	(International)																																
BS 4066 PART 3	(UK)																																
CEI 20-22	(Italy)																																
VDE 804C	(Germany)																																
NF C 32-070 CAT. C1	(France)																																
IEEE 383	(USA)																																
UL 1581	(USA)																																
UL 1666	(USA)																																
FT4	(Canada)																																
AS 1660.5.1	(Australia)																																
IEC 60754 PART 1	(International)																																
IEC 60754 PART 2	(International)																																
CEI 20-37 PART 1	(Italy)																																
VDE 0472 PART 813	(Germany)																																
NF C 20-453	(France)																																
AS 1660.5.4	(Australia)																																
Smoke	Toxicity																																
<table border="0"> <tr><td>IEC 61034</td><td>(International)</td></tr> <tr><td>UITP E4</td><td>(International)</td></tr> <tr><td>BS 7622</td><td>(UK)</td></tr> <tr><td>UTE C 20-452</td><td>(France)</td></tr> <tr><td>CEI 20-37 PART 3 - METHOD</td><td>(Italy)</td></tr> <tr><td>ASTM E662</td><td>(USA)</td></tr> <tr><td>AS 1660.5.2</td><td>(Australia)</td></tr> </table> <p>Several materials used in the manufacture of electric wires and cables can liberate large volumes of dense black smoke when ignited. LSHF Cables however, are designed to produce only limited amounts of smoke when they are exposed to fire. This property helps to improve safety in areas where there are limited means of escape in the event of an emergency, or where large crowds are regularly in attendance.</p>	IEC 61034	(International)	UITP E4	(International)	BS 7622	(UK)	UTE C 20-452	(France)	CEI 20-37 PART 3 - METHOD	(Italy)	ASTM E662	(USA)	AS 1660.5.2	(Australia)	<table border="0"> <tr><td>Naval Engineering Standard 713</td><td>(UK)</td></tr> <tr><td>CEI 20-37 PART 2</td><td>(Italy)</td></tr> <tr><td>NF C 20-454</td><td>(France)</td></tr> </table> <p>The evolution of toxic fumes from burning materials has been of concern to a variety of industries. In the case of electric wires and cables, toxic gases are of particular importance where they may hamper the safe escape of people in an emergency, or incapacitate personnel engaged in vital operations. LSHF Cables do not liberate the highly toxic species generated by some other cable materials as in the case of LSHF Cables the main products of combustion are water and carbon dioxide. LSHF Cables comply with most military toxic gas evolution specifications.</p>	Naval Engineering Standard 713	(UK)	CEI 20-37 PART 2	(Italy)	NF C 20-454	(France)												
IEC 61034	(International)																																
UITP E4	(International)																																
BS 7622	(UK)																																
UTE C 20-452	(France)																																
CEI 20-37 PART 3 - METHOD	(Italy)																																
ASTM E662	(USA)																																
AS 1660.5.2	(Australia)																																
Naval Engineering Standard 713	(UK)																																
CEI 20-37 PART 2	(Italy)																																
NF C 20-454	(France)																																

CONSTRUCTION OF CABLE

Construction	
1 - Conductor	Stranded annealed copper
2 - Insulation	XLPE or Low smoke halogen free (LSHF) compound
3 - Shield*	Aluminium foil with tinned copper drain wire
4 - Filler*	LSHF filler or polypropylene split yarn
5 - Binder Tape*	Polyester tape
6 - Bedding*	Low smoke halogen free (LSHF) compound
7 - Armour* / #	Galvanised steel wire (aluminium or copper wire for single core)
8 - Sheath	Low smoke halogen free (LSHF) compound

* Optional: Depending on requirement
 # Braided armour also available on request

FOUR PAIR

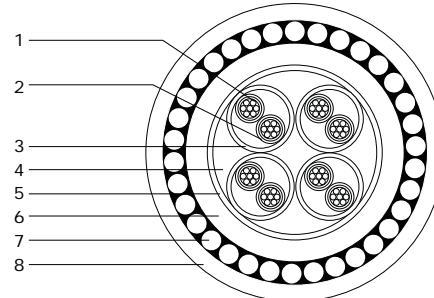

FOUR CORE

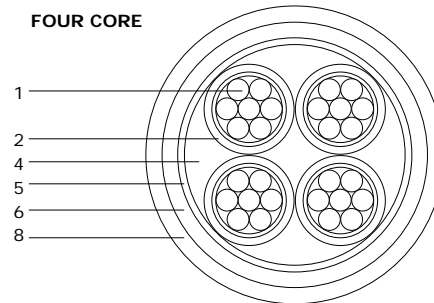

SINGLE CORE

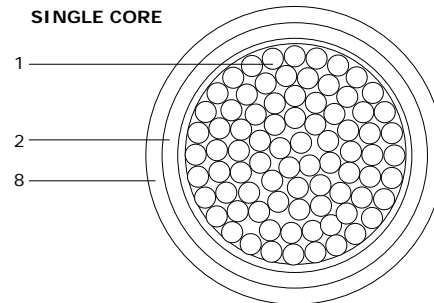

Identification of cores:

No. of cores	Identification of cores	
	Option 1	Option 2
1	Natural	Other colour on request
2	Brown, Blue	Red, Black
3	Brown, Black, Grey	Red, Yellow Blue
4	Brown, Black, Grey, Blue	Red, Yellow, Blue, Black
5	Brown, Black, Grey, Blue, Green/Yellow	Red, Yellow, Blue, Black, Green/Yellow
6 and above	Black with white numbering (Others on request)	
Pairs	Black with white numbering	

Note: Special construction and design to customers' specification can be provided upon request.

Applicable Standards

IEC 60502-1	Extruded solid dielectric insulated power cables for rated voltage of 1 kV up to 30 kV
IEC 60228/BS 6360	Conductors of insulated cables
IEC 60754-1/BS 6425-1	Test on gases evolved during combustion of electric cables - Determination of the amount of halogen acid gases
IEC 60754-2/BS 6425-2	Test on gases evolved during combustion of electric cables - Determination of degree of acidity of gases evolved by measuring PH and conductivity
IEC 61034/BS 7622	Measurement of smoke density of electric cables burning under defined conditions
BS 6724	Armoured cables for electricity supply having thermosetting insulation with low emission of smoke and corrosive gases when affected by fire
BS 7211	Thermosetting insulated cables (non-armoured) for electric power and lighting with low emission of smoke and corrosive gases when affected by fire
BS 7846	600/1000V armoured fire-resistant electric cables having low emission of smoke and corrosive gases when affected by fire
IEC 60332-3	Test of the fire behaviour on bunched cables (Reduced flame propagation)



TABLE OF CONSTRUCTION

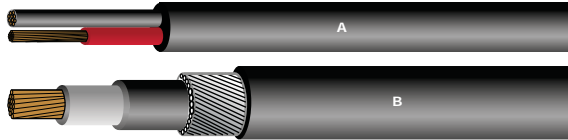

600/1000V, Unarmoured and Armoured LSHF Cables

Table 1

	(A) Unarmoured Cables								(B) Armoured Cables				
	Nominal area of conductor	Insulated, non-sheathed			Insulated and Sheathed				Insulated and Sheathed				
		Insulation Thickness	Approx. diameter overall	Approx. weight	Insulation Thickness	Sheath Thickness	Approx. diameter overall	Approx. weight	Bedding Thickness	Armour wire diameter	Sheath Thickness	Approx. diameter overall	Approx. weight
mm ²	mm	mm	kg/km	mm	mm	mm	kg/km	mm	mm	mm	mm	kg/km	
Single Core	1.5	0.7	3.9	32	0.7	1.4	6.4	55	-	-	-	-	-
	2.5	0.8	4.6	43	0.7	1.4	6.8	70	-	-	-	-	-
	4	0.8	5.1	55	0.7	1.4	7.4	90	-	-	-	-	-
	6	0.8	5.6	85	0.7	1.4	7.9	110	-	-	-	-	-
	10	1.0	7.1	146	0.7	1.4	8.9	160	-	-	-	-	-
	16	1.0	8.1	198	0.7	1.4	9.9	220	-	-	-	-	-
	25	1.2	9.8	320	0.9	1.4	12.2	330	-	-	-	-	-
	35	1.2	10.9	410	0.9	1.4	13.5	430	-	-	-	-	-
	50	1.4	13.4	549	1.0	1.4	15.0	560	1.0	1.25	1.8	19.6	800
	70	1.4	15.2	770	1.1	1.4	17.0	770	1.0	1.25	1.8	22.5	1000
	95	1.6	17.6	1140	1.1	1.5	19.0	1040	1.0	1.25	1.8	24.0	1400
	120	1.6	19.3	1425	1.2	1.5	20.8	1290	1.0	1.60	1.8	27.0	1700
	150	1.8	21.3	1720	1.4	1.6	23.0	1580	1.0	1.60	1.8	29.0	2000
	185	2.0	23.7	2155	1.6	1.6	25.3	1950	1.0	1.60	1.9	31.3	2400
	240	2.2	26.8	2900	1.7	1.7	28.3	2530	1.0	1.60	2.0	35.0	3300
	300	2.4	29.7	3540	1.8	1.8	31.0	3140	1.0	1.60	2.1	37.0	3800
	400	2.6	33.3	4410	2.0	1.9	34.7	3970	1.2	2.00	2.3	42.0	4800
	500	2.8	37.2	5660	2.2	2.0	38.5	4970	1.2	2.00	2.4	46.0	5900
630	2.8	41.3	7140	2.4	2.2	43.5	6400	1.2	2.00	2.5	51.0	7400	
800	-	-	-	2.6	2.3	48.0	8000	1.4	2.00	2.8	57.0	9400	
1000	-	-	-	2.8	2.4	53.2	10200	1.4	2.00	2.9	62.0	11000	
Two Cores	1.5	-	-	-	0.7	1.8	10.4	150	1.0	0.90	1.8	15.0	400
	2.5	-	-	-	0.7	1.8	11.2	180	1.0	0.90	1.8	16.0	450
	4	-	-	-	0.7	1.8	12.3	240	1.0	0.90	1.8	17.0	530
	6	-	-	-	0.7	1.8	13.5	300	1.0	0.90	1.8	18.0	620
	10	-	-	-	0.7	1.8	15.7	420	1.0	1.25	1.8	20.0	900
	16	-	-	-	0.7	1.8	17.8	590	1.0	1.25	1.8	22.0	1050
	25	-	-	-	0.9	1.8	21.2	860	1.0	1.60	1.8	26.5	1600
	35	-	-	-	0.9	1.8	23.7	1120	1.0	1.60	1.9	29.0	1964

A Unarmoured cables
B Armoured cables

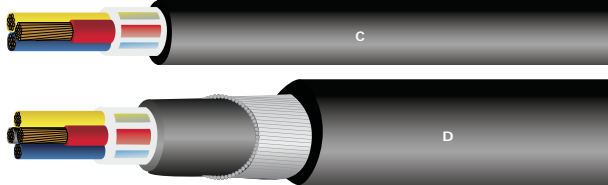

600/1000V, Unarmoured and Armoured LSHF Cables

Table 2

	(C) Unarmoured Cables					(D) Armoured Cables				
	Nominal area of conductor	Insulation Thickness	Sheath Thickness	Approx. diameter overall	Approx. weight	Bedding Thickness	Armour wire diameter	Sheath Thickness	Approx. diameter overall	Approx. weight
	mm ²	mm	mm	mm	kg/km	mm	mm	mm	mm	kg/km
Three Cores	1.5	0.7	1.8	10.0	170	1.0	0.90	1.8	14.5	400
	2.5	0.7	1.8	11.0	215	1.0	0.90	1.8	15.4	470
	4	0.7	1.8	12.1	280	1.0	0.90	1.8	16.5	560
	6	0.7	1.8	13.3	360	1.0	1.25	1.8	16.5	770
	10	0.7	1.8	15.3	510	1.0	1.25	1.8	20.5	1000
	16	0.7	1.8	17.6	740	1.0	1.60	1.8	23.4	1400
	25	0.9	1.8	21.3	1100	1.0	1.60	1.8	28.0	1900
	35	0.9	1.8	24.0	1400	1.0	1.60	1.9	30.3	2400
	50	1.0	1.8	27.1	1900	1.0	1.60	2.1	34.5	3140
	70	1.1	2.0	32.0	2600	1.2	2.00	2.2	39.5	4150
	95	1.1	2.1	37.0	3500	1.2	2.00	2.4	43.9	5400
	120	1.2	2.3	42.0	4400	1.4	2.50	2.6	49.6	6830
	150	1.4	2.4	45.0	5500	1.4	2.50	2.7	54.1	8080
	185	1.6	2.6	50.3	6800	1.4	2.50	2.9	59.4	9720
240	1.7	2.8	56.8	8800	1.6	2.50	3.1	66.3	12000	
300	1.8	3.0	62.8	10900	1.6	3.15	3.3	74.0	15500	
Four Cores	1.5	0.7	1.8	10.8	180	1.0	0.90	1.8	15.3	450
	2.5	0.7	1.8	11.8	240	1.0	0.90	1.8	16.3	530
	4	0.7	1.8	13.1	320	1.0	1.25	1.8	18.3	740
	6	0.7	1.8	14.7	430	1.0	1.25	1.8	19.6	900
	10	0.7	1.8	16.7	629	1.0	1.25	1.8	21.9	1150
	16	0.7	1.8	19.3	870	1.0	1.60	1.8	25.3	1620
	25	0.9	1.8	23.4	1330	1.0	1.60	1.9	30.0	2260
	35	0.9	1.8	26.4	1770	1.0	1.60	2.0	33.9	3060
	50	1.0	1.8	30.0	2330	1.2	2.00	2.2	37.9	3860
	70	1.1	2.1	35.5	3350	1.2	2.00	2.3	43.1	5080
	95	1.1	2.3	40.4	4530	1.4	2.50	2.6	49.5	6980
	120	1.2	2.4	45.1	5710	1.4	2.50	2.7	54.2	8420
	150	1.4	2.6	50.1	7000	1.6	2.50	2.9	59.7	10080
	185	1.6	2.8	56.0	8770	1.6	2.50	3.1	65.6	12190
240	1.7	3.0	63.3	11360	1.6	3.15	3.4	74.3	16050	
300	1.8	3.2	70.1	14200	1.6	3.15	3.6	81.5	19420	

C. Unarmoured cables

D. Armoured cables

* Multicore unarmoured and armoured fire resistant cables are available upon request

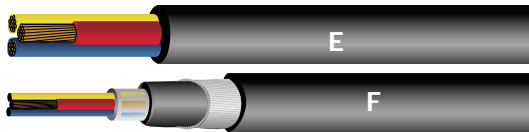

500V, Unarmoured and Armoured LSHF Cables

Table 3

	(E) Unarmoured Cables						(F) Armoured Cables				
	Nominal area of conductor	No. & Diameter of wires	Insulation Thickness	Sheath Thickness	Approx. diameter overall	Approx. weight	Bedding Thickness	Armour wire diameter	Sheath Thickness	Approx. diameter overall	Approx. weight
	mm ²	No. /mm	mm	mm	mm	kg/km	mm	mm	mm	mm	kg/km
Single Core	0.75	7/0.37	0.55	0.5	4.1	22	0.5	0.9	1.4	8.9	155
	1	7/0.44	0.55	0.5	4.3	26	0.5	0.9	1.4	9.1	165
	1.5	7/0.53	0.55	0.5	4.6	32	0.5	0.9	1.4	9.4	180
	2.5	7/0.67	0.55	0.5	5.0	43	0.5	0.9	1.4	9.8	200
	4	7/0.85	0.55	0.5	5.6	60	0.5	0.9	1.4	10.4	240
Two Cores	0.75	7/0.37	0.55	0.5	7.0	64	0.5	0.9	1.4	11.8	285
	1	7/0.44	0.55	0.5	7.4	74	0.5	0.9	1.4	12.2	310
	1.5	7/0.53	0.55	0.5	8.0	92	0.5	0.9	1.4	12.8	345
	2.5	7/0.67	0.55	0.5	8.8	120	0.5	0.9	1.4	13.6	400
	4	7/0.85	0.55	0.5	9.9	165	0.5	0.9	1.4	14.7	475
Three Cores	0.75	7/0.37	0.55	0.5	7.5	75	0.5	0.9	1.4	12.3	310
	1	7/0.44	0.55	0.5	7.9	88	0.5	0.9	1.4	12.7	355
	1.5	7/0.53	0.55	0.5	8.5	110	0.5	0.9	1.4	13.3	375
	2.5	7/0.67	0.55	0.5	9.4	150	0.5	0.9	1.4	14.2	445
	4	7/0.85	0.55	0.5	10.6	205	0.5	0.9	1.4	15.4	535
Four Cores	0.75	7/0.37	0.55	0.5	8.3	90	0.5	0.9	1.4	13.1	360
	1	7/0.44	0.55	0.5	8.7	105	0.5	0.9	1.4	13.5	380
	1.5	7/0.53	0.55	0.5	9.4	135	0.5	0.9	1.4	14.2	430
	2.5	7/0.67	0.55	0.5	10.4	180	0.5	0.9	1.4	15.2	500
	4	7/0.85	0.55	0.5	11.7	255	0.5	0.9	1.4	16.7	620

E Unarmoured fire resistant cable

F Armoured fire resistant cable

* Multicore unarmoured and armoured fire resistant cables are available upon request



500V, Unarmoured and Armoured LSHF Cables

Table 4

	(E) Unarmoured Cables						(F) Armoured Cables				
	Nominal area of conductor	No. & Diameter of wires	Insulation Thickness	Sheath Thickness	Approx. diameter overall	Approx. weight	Bedding Thickness	Armour wire diameter	Sheath Thickness	Approx. diameter overall	Approx. weight
	mm ²	No./mm	mm	mm	mm	kg/km	mm	mm	mm	mm	kg/km
One pair	0.75	7/0.37	0.5	0.8	7.9	65	0.8	0.9	1.4	12.7	300
	1	7/0.43	0.6	0.8	8.5	75	0.8	0.9	1.4	13.3	340
	1.5	7/0.53	0.5	0.8	9.1	90	0.8	0.9	1.4	13.9	370
	2.5	7/0.67	0.6	0.8	9.9	110	0.8	0.9	1.4	14.7	420
Two pair	0.75	7/0.37	0.5	0.8	10.0	100	0.8	0.9	1.4	14.8	410
	1	7/0.43	0.6	0.9	11.0	125	0.9	0.9	1.4	15.8	460
	1.5	7/0.53	0.6	0.9	11.8	150	0.9	0.9	1.5	16.8	520
	2.5	7/0.67	0.6	1.0	13.1	205	1.0	0.9	1.5	18.1	605
Three pair	0.75	7/0.37	0.5	1.0	12.2	145	1.0	0.9	1.5	17.2	565
	1	7/0.43	0.6	1.0	13.1	170	1.0	0.9	1.5	18.1	600
	1.5	7/0.53	0.6	1.0	14.1	215	1.0	0.9	1.6	19.3	655
	2.5	7/0.67	0.6	1.1	15.7	290	1.1	1.25	1.6	21.6	920
Four pair	0.75	7/0.37	0.5	1.0	13.7	180	1.0	0.9	1.5	18.7	600
	1	7/0.43	0.6	1.0	14.7	215	1.0	1.25	1.6	20.6	820
	1.5	7/0.53	0.6	1.1	16.1	280	1.1	1.25	1.6	22.0	920
	2.5	7/0.67	0.6	1.1	17.7	370	1.1	1.25	1.6	23.8	1090

G Unarmoured fire resistant cable

H Armoured fire resistant cable

* Multi-pairs unarmoured and armoured shielded fire resistant cables are available upon request



TECHNICAL INFORMATION

WE EXTENDED PRODUCT OFFER
WORLDWIDE LEA
SUPPORTING GLOBAL UTILITIES IN THE D
OF SMARTER AND GREENER POWER GR
STRONGER PLATFORM

ตารางที่ 5-27

ขนาดกระแสของสายไฟฟ้าตัวนำทองแดงหุ้มฉนวนครอสลิงกด์พอลิเอทิลีน มีเปลือกนอก สำหรับขนาดแรงดัน (U₀/U) ไม่เกิน 0.6/1 กิโลโวลต์ อุณหภูมิตัวนำ 90 °C อุณหภูมิโดยรอบ 40 °C เดินร้อยในท่อในอากาศ



ลักษณะการติดตั้ง	กลุ่มที่ 1				กลุ่มที่ 2			
	2		3		2		3	
จำนวนตัวนำกระแส	แกนเดี่ยว	หลายแกน	แกนเดี่ยว	หลายแกน	แกนเดี่ยว	หลายแกน	แกนเดี่ยว	หลายแกน
รูปแบบการติดตั้ง								
รหัสชนิดผลิตภัณฑ์ใช้งาน	IEC 60502-1 และสายที่มีคุณสมบัติพิเศษต่างๆ เช่น สายทนไฟ, สายไร้ฮาโลเจน, สายควีนน้อย เป็นต้น							
ขนาดสาย (ตร.มม.)	ขนาดกระแส (แอมแปร์)							
1	13	13	12	12	15	15	14	14
1.5	17	17	15	15	21	20	18	18
2.5	24	23	21	20	28	27	25	24
4	32	30	28	27	38	36	34	32
6	41	38	36	35	49	46	44	40
10	56	52	49	46	68	63	60	55
16	74	69	66	62	91	83	80	73
25	96	90	86	81	121	108	106	96
35	119	110	106	99	149	133	131	116
50	144	132	128	118	180	159	159	140
70	182	167	163	149	230	201	202	177
95	219	200	197	179	278	241	245	212
120	253	230	227	207	322	278	284	244
150	289	264	259	236	358	304	311	273
185	329	299	295	268	409	349	349	309
240	386	351	346	315	480	418	410	362
300	442	402	396	360	549	484	468	414
400	-	-	-	-	622	-	531	-
500	-	-	-	-	713	-	606	-

หมายเหตุ (ตารางที่ 5-27)

- 1) อุณหภูมิโดยรอบที่แตกต่างจาก 40 °C ให้ใช้ตัวคูณปรับค่าตามที่ระบุไว้ในตารางที่ 5-43
- 2) ในกรณีที่มีจำนวนตัวนำกระแสมากกว่า 1 กลุ่มวงจร ในท่อร้อยสาย ให้ใช้ตัวคูณปรับค่าตามที่ระบุไว้ใน ตารางที่ 5-8
- 3) ดูคำอธิบายรูปแบบการติดตั้งในตารางที่ 5-47

ตารางที่ 5-28

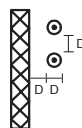
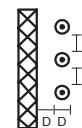
ขนาดกระแสของสายไฟฟ้าแกนเดี่ยวตัวนำทองแดงหุ้มฉนวนครอสลิงกด์พอลิเอทิลีน สำหรับขนาดแรงดัน (U₀/U) ไม่เกิน 0.6/1 กิโลโวลต์ อุณหภูมิตัวนำ 90 °C อุณหภูมิโดยรอบ 40 °C เดินบนฉนวนลูกลอยในอากาศ

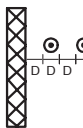
ลักษณะการติดตั้ง	กลุ่มที่ 4	
รูปแบบการติดตั้ง	 หรือ 	 หรือ 
รหัสชนิดเคเบิลที่ใช้งาน	ตามมาตรฐาน IEC 60502-1	
ขนาดสาย (ตร.มม.)	ขนาดกระแส (แอมแปร์)	
4	47	54
6	60	68
10	82	90
16	110	124
25	147	166
35	183	206
50	224	250
70	289	321
95	354	391
120	413	455
150	480	525
185	551	602
240	654	711
300	758	821
400	917	987
500	1,064	1,140

หมายเหตุ (ตารางที่ 5-28)

ดูคำอธิบายรูปแบบการติดตั้งในตารางที่ 5-47

ตารางที่ 5-29

ขนาดกระแสของสายไฟฟ้าตัวนำทองแดงหุ้มฉนวนครอสลิงค์พอลิเอทิลีน มีเปลือกนอก ขนาดแรงดัน (U₀/U) ไม่เกิน 0.6/1 กิโลโวลต์ อุณหภูมิตัวนำ 90 °C อุณหภูมิโดยรอบ 30 °C ร้อยต่อฝังดินหรือฝังดินโดยตรง

ลักษณะการติดตั้ง	กลุ่มที่ 5		กลุ่มที่ 6
จำนวนตัวนำกระแส	2	3	ไม่เกิน 3
ลักษณะตัวนำ	แกนเดี่ยว / หลายแกน	แกนเดี่ยว / หลายแกน	แกนเดี่ยว / หลายแกน
รูปแบบการติดตั้ง			
รหัสชนิดเคเบิลที่ใช้งาน	IEC 60502-1		
ขนาดสาย (ตร.ม.ม.)	ขนาดกระแส (แอมแปร์)		
1.5	25	22	33
2.5	33	29	43
4	43	38	55
6	54	47	70
10	71	63	92
16	94	83	119
25	124	109	152
35	150	132	184
50	180	159	217
70	223	196	266
95	271	238	318
120	313	275	362
150	355	312	406
185	406	356	459
240	477	418	533
300	543	475	601
400	625	545	684
500	717	623	777

หมายเหตุ (ตารางที่ 5-29)

- 1) อุณหภูมิโดยรอบที่แตกต่างจาก 30 °C ให้ใช้ตัวคูณปรับค่าตามที่ระบุไว้ในตารางที่ 5-44
- 2) ในกรณีเดินเป็นกลุ่มมากกว่า 1 วงจร ให้ใช้ตัวคูณปรับค่าตามที่ระบุไว้ในตาราง 5-45 หรือ 5-46
- 3) ในกรณีมีจำนวนตัวนำกระแสมากกว่า 1 กลุ่มวงจร ในที่ร้อยสาย ให้ใช้ตัวคูณปรับค่าตามที่ระบุไว้ใน ตารางที่ 5-8
- 4) ดูคำอธิบายรูปแบบการติดตั้ง ในตารางที่ 5-47
- 5) งานติดตั้งระบบไฟฟ้าที่เป็นทรัพย์สินของการไฟฟ้าฯ ให้พิจารณาขนาดกระแสตามมาตรฐานการไฟฟ้าฯ ยกเว้นไม่มีกำหนดไว้

ตารางที่ 5-32

ขนาดกระแสของสายไฟฟ้าตัวนำทองแดงหุ้มฉนวนครอสลิงกด์พอลิเอทิลีน มีเปลือกนอก สำหรับขนาดแรงดัน (U_0/U) ไม่นเกิน 0.6/1 กิโลโวลต์ อุณหภูมิตัวนำ 90 °C อุณหภูมิโดยรอบ 40 °C วางบนรางเคเบิลแบบระบายอากาศ ไม่มีฝาปิด หรือรางเคเบิลแบบแบนได้

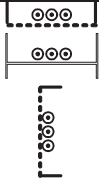
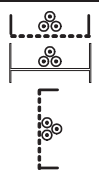
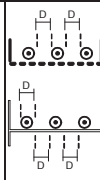
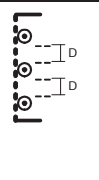
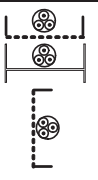



ลักษณะการติดตั้ง	กลุ่มที่ 7				
	แกนเดี่ยว				หลายแกน
รูปแบบการติดตั้ง					
รหัสชนิดเคเบิลใช้งาน	IEC 60502-1 และสายที่มีคุณสมบัติพิเศษต่างๆ เช่น สายทนไฟ, สายไร้ฮาโลเจน, สายฉนวนชั้นเป็นชั้น				
ขนาดสาย (ตร.มม.)	ขนาดกระแส (แอมแปร์)				
1	-	-	-	-	16
1.5	-	-	-	-	21
2.5	-	-	-	-	29
4	-	-	-	-	38
6	-	-	-	-	49
10	-	-	-	-	68
16	-	-	-	-	91
25	128	123	166	147	116
35	160	154	206	183	144
50	197	188	250	224	175
70	254	244	321	289	224
95	311	298	391	354	271
120	364	349	455	413	315
150	422	404	525	480	363
185	485	464	602	551	415
240	577	552	711	654	490
300	670	640	821	758	565
400	790	749	987	917	-
500	908	861	1,140	1,064	-

หมายเหตุ (ตารางที่ 5-32)

- 1) อุณหภูมิโดยรอบที่แตกต่างจาก 40 °C ให้ใช้ตัวคูณปรับค่าตามที่ระบุไว้ในตารางที่ 5-43
- 2) ในกรณีที่มีจำนวนตัวนำกระแสมากกว่า 1 กลุ่มวงจร ให้ใช้ตัวคูณปรับค่าตามที่ระบุไว้ในตารางที่ 5-40 และตารางที่ 5-41 สำหรับสายแกนเดี่ยวและสายหลายแกน ตามลำดับ
- 3) ดูคำอธิบายรูปแบบการติดตั้งในตารางที่ 5-47

ตารางที่ 5-33

ขนาดกระแสของสายไฟฟ้าตัวนำทองแดงหุ้มฉนวนครอสลิงกด์พอลิเอทิลีน มีเปลือกนอก สำหรับขนาดแรงดัน (U₀/U) ไม่เกิน 0.6/1 กิโลโวลต์ อุณหภูมิตัวนำ 90 °C อุณหภูมิโดยรอบ 40 °C วางบนรางเคเบิลชนิดด้านล่างทึบ มี ไม่มี ฝาปิด

ลักษณะการติดตั้ง	กลุ่มที่ 7			
	แกนเดี่ยว		หลายแกน	
รูปแบบการติดตั้ง				
รหัสชนิดเคเบิลที่ใช้	IEC 60502-1 และสายที่มีคุณสมบัติพิเศษต่างๆ เช่น สายทนไฟ, สายไร้ฮาโลเจน, สายคว้านน้อย เป็นต้น			
ขนาดสาย (ตร.มม.)	ขนาดกระแส (แอมแปร์)			
1	-	-	15	14
1.5	-	-	20	18
2.5	-	-	27	24
4	-	-	36	32
6	-	-	47	40
10	-	-	65	55
16	-	-	87	73
25	118	106	108	96
35	147	131	134	116
50	190	159	163	140
70	244	202	208	177
95	297	245	253	212
120	345	284	293	244
150	397	311	338	273
185	455	349	386	309
240	537	410	455	362
300	620	468	524	414
400	722	531	-	-
500	823	606	-	-

หมายเหตุ (ตารางที่ 5-33)

- 1) อุณหภูมิโดยรอบที่แตกต่างจาก 40 °C ให้ใช้ตัวคูณปรับค่าตามที่ระบุไว้ในตารางที่ 5-43
- 2) ในกรณีที่มีจำนวนตัวนำกระแสมากกว่า 1 กลุ่มวงจร สำหรับรางเคเบิลแบบมีฝาปิดให้ใช้ตัวคูณปรับค่า ตามที่ระบุไว้ในตารางที่ 5-33(ก) และสำหรับรางเคเบิลแบบไม่มีฝาปิดให้ใช้ตัวคูณปรับค่าตามที่ระบุไว้ในตารางที่ 5-41

ยกเว้น การจัดวางระยะห่างระหว่างกลุ่มวงจรมากกว่าสองเท่าของผลรวมเส้นผ่านศูนย์กลาง ภายนอกของตัวนำกระแส ไม่ต้องนำตัวคูณปรับค่าตามตารางมาพิจารณา

ตารางที่ 5-33(ก)

จำนวนกลุ่มวงจร	ตัวคูณปรับค่า
2	0.8
3	0.7
4	0.65
5	0.6
6	0.57
7	0.54
8	0.52
9	0.50
10-12	0.45
13-16	0.41
17-20	0.38

3) ดูคำอธิบายรูปแบบการติดตั้งในตารางที่ 5-47

ตารางที่ 5-40

ตัวคูณปรับค่าขนาดกระแสสำหรับสายเคเบิลแกนเดี่ยว วางบนรางเคเบิล เป็นกลุ่มมากกว่า 1 วงจร

วิธีการติดตั้ง	จำนวน รางเคเบิล	จำนวนกลุ่มวงจรต่อรางเคเบิล							ลักษณะการ จัดเรียงเคเบิล
		1	2	3	4	5-6	7-9		
รางเคเบิลแบบ ระบายอากาศ (หมายเหตุ 2) 	1	1.00	0.91	0.87	0.82	0.78	0.77	รูปแบบวางซิด กันใน แนวนอน	
	2	0.96	0.87	0.81	0.78	0.74	0.69		
	3	0.95	0.85	0.78	0.75	0.70	0.65		
รางเคเบิลแบบ ระบายอากาศวาง แนวตั้ง (หมายเหตุ 3) 	1	1.00	0.86	0.80	0.75	0.71	0.70	รูปแบบวางซิด กันในแนวตั้ง	
	2	0.95	0.84	0.77	0.72	0.67	0.66		
รางเคเบิลแบบ แบนได (หมายเหตุ 2) 	1	1.00	0.97	0.96	0.94	0.93	0.92	รูปแบบวางซิด กันใน แนวนอน	
	2	0.98	0.93	0.89	0.88	0.86	0.83		
	3	0.97	0.90	0.86	0.83	0.80	0.77		
รางเคเบิลแบบ ระบายอากาศ (หมายเหตุ 2) 	1	1.00	0.98	0.96	0.93	0.89	-	รูปแบบวางซิด กันแบบ	
	2	0.97	0.93	0.89	0.85	0.80	-		
	3	0.96	0.92	0.86	0.82	0.76	-		
รางเคเบิลแบบ ระบายอากาศวาง แนวตั้ง (หมายเหตุ 3) 	1	1.00	0.91	0.89	0.88	0.87	-	สามเหลี่ยม ห่างกันไม่ น้อยกว่า 2 เท่า ของเส้น	
	2	1.00	0.90	0.86	0.85	0.83	-		
รางเคเบิลแบบ แบนได (หมายเหตุ 2) 	1	1.00	1.00	1.00	1.00	1.00	-	ผ่าน ศูนย์กลาง เคเบิล	
	2	0.97	0.95	0.93	0.92	0.91	-		
	3	0.96	0.94	0.90	0.89	0.86	-		

ตารางที่ 5-40 (ต่อ)

ตัวคูณปรับค่าขนาดกระแสสำหรับสายเคเบิลแกนเดี่ยว วางบนรางเคเบิล เป็นกลุ่มมากกว่า 1 วงจร

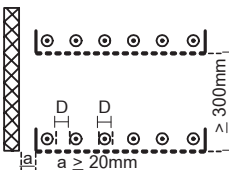
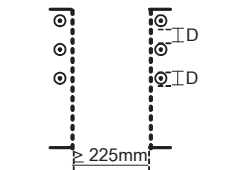
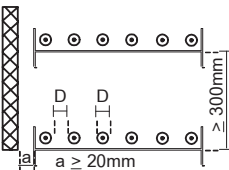
วิธีการติดตั้ง	จำนวน ราง เคเบิล	จำนวนกลุ่มวงจรต่อรางเคเบิล						ลักษณะ การจัดเรียง เคเบิล
		1	2	3	4	5-6	7-9	
รางเคเบิลแบบ ระบายอากาศ (หมายเหตุ 2) 	1	1.00	0.93	0.90	0.87	0.83	-	รูปแบบวาง ห่างกันไม่ น้อยกว่า เส้นผ่าน ศูนย์กลาง เคเบิล
	2	0.97	0.89	0.85	0.81	0.76	-	
	3	0.96	0.88	0.82	0.78	0.72	-	
รางเคเบิลแบบ ระบายอากาศวาง แนวตั้ง (หมายเหตุ 3) 	1	1.00	0.91	0.89	0.88	0.87	-	ห่างกันไม่ น้อยกว่า เส้นผ่าน ศูนย์กลาง เคเบิล
	2	0.94	0.90	0.86	0.85	0.83	-	
รางเคเบิลแบบแบน (หมายเหตุ 2) 	1	1.00	0.97	0.96	0.96	0.96	-	รูปแบบวาง ห่างกันไม่ น้อยกว่า เส้นผ่าน ศูนย์กลาง เคเบิล
	2	0.97	0.94	0.93	0.92	0.91	-	
	3	0.96	0.93	0.92	0.91	0.88	-	

หมายเหตุ (ตารางที่ 5-40)

- 1) ตัวคูณปรับค่าขนาดกระแสให้ใช้กับการวางสายไฟฟ้าชั้นเดียวเท่านั้น
- 2) ตัวคูณปรับค่าขนาดกระแสให้ใช้กับการติดตั้งรางเคเบิลในแนวอนที่มีระยะห่างระหว่างรางเคเบิลในแนวตั้ง ไม่น้อยกว่า 300 มม. และติดตั้งรางเคเบิลห่างจากผนังไม่น้อยกว่า 20 มม. เท่านั้น
- 3) ตัวคูณปรับค่าขนาดกระแสให้ใช้กับการติดตั้งรางเคเบิลในแนวตั้งที่มีระยะห่างระหว่างรางเคเบิลในแนวราบ ไม่น้อยกว่า 225 มม. เท่านั้น
- 4) ในกรณีที่มีจำนวนรางเคเบิลมากกว่าหนึ่งราง ตัวคูณปรับค่าให้คิดจากรางเคเบิลที่มีกลุ่มวงจรมากที่สุด

ตารางที่ 5-41

ตัวคูณปรับค่าขนาดกระแสสำหรับสายเคเบิลหลายแกน วางบนรางเคเบิลแบบระบายอากาศ แบบด้านล่างทึบ หรือแบบบันได เมื่อวางเป็นกลุ่มมากกว่า 1 วงจร

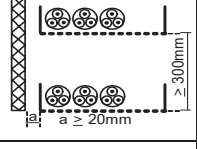
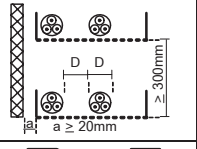
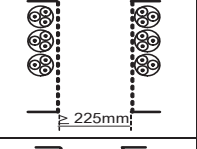
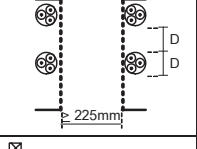
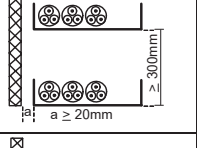
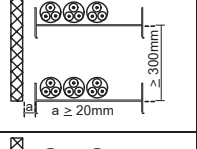
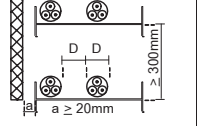
วิธีการติดตั้ง	จำนวนรางเคเบิล	จำนวนเคเบิลต่อรางเคเบิล						
		1	2	3	4	5-6	7-9	
รางเคเบิลแบบระบายอากาศ (หมายเหตุ 2)) 	1	1.0	0.88	0.82	0.77	0.73	0.72	
	2	1.0	0.87	0.80	0.77	0.73	0.68	
	3	1.0	0.86	0.79	0.76	0.71	0.66	
	4-6	1.0	0.84	0.77	0.73	0.68	0.64	
		1	1.0	1.0	0.98	0.95	0.91	-
		2	1.0	0.99	0.96	0.92	0.87	-
3		1.0	0.98	0.95	0.91	0.85	-	
รางเคเบิลแบบระบายอากาศวางแนวตั้ง (หมายเหตุ 3)) 	1	1.0	0.88	0.82	0.77	0.73	0.72	
	2	1.0	0.88	0.81	0.76	0.71	0.70	
		1	1.0	0.91	0.89	0.88	0.87	-
		2	1.0	0.91	0.88	0.87	0.85	-
รางเคเบิลแบบด้านล่างทึบ (หมายเหตุ 2)) 	1	0.97	0.84	0.78	0.75	0.71	0.68	
	2	0.97	0.83	0.76	0.72	0.68	0.63	
	3	0.97	0.82	0.75	0.71	0.66	0.61	
	4-6	0.97	0.81	0.73	0.69	0.63	0.58	
รางเคเบิลแบบบันได (หมายเหตุ 2)) 	1	1.0	0.87	0.82	0.80	0.79	0.78	
	2	1.0	0.86	0.80	0.78	0.76	0.73	
	3	1.0	0.85	0.79	0.76	0.73	0.70	
	4-6	1.0	0.84	0.77	0.73	0.68	0.64	
		1	1.0	1.0	1.0	1.0	1.0	-
		2	1.0	0.99	0.98	0.97	0.96	-
3		1.0	0.98	0.97	0.96	0.93	-	

หมายเหตุ (ตารางที่ 5-41)

- 1) ตัวคูณปรับค่าขนาดกระแสให้ใช้กับการวางสายไฟฟ้าชั้นเดียวเท่านั้น
- 2) ตัวคูณปรับค่าขนาดกระแสให้ใช้กับการติดตั้งรางเคเบิลในแนวนอนที่มีระยะห่างระหว่างรางเคเบิลในแนวตั้ง ไม่น้อยกว่า 300 มม. และติดตั้งรางเคเบิลห่างจากผนังไม่น้อยกว่า 20 มม. เท่านั้น
- 3) ตัวคูณปรับค่าขนาดกระแสให้ใช้กับการติดตั้งรางเคเบิลในแนวตั้งที่มีระยะห่างระหว่างรางเคเบิลในแนวราบ ไม่น้อยกว่า 225 มม. เท่านั้น
- 4) ในกรณีที่จำนวนรางเคเบิลมากกว่าหนึ่งราง ตัวคูณปรับค่าให้คิดจากรางเคเบิลที่มีกลุ่มวงจรมากที่สุด

ตารางที่ 5-43

คูณปรับค่าอุณหภูมิโดยรอบที่แตกต่างจาก 40 °C ใช้กับค่าขนาดกระแสของเคเบิล เมื่อเดินในอากาศ

อุณหภูมิโดยรอบ (องศาเซลเซียส)	จนวน			
	PVC	XLPE หรือ EPR	เอ็มไอ	
			70°C	105°C
11-15	1.34	1.23	1.41	1.21
16-20	1.29	1.19	1.34	1.16
21-25	1.22	1.14	1.26	1.13
26-30	1.15	1.10	1.18	1.09
31-35	1.08	1.05	1.09	1.04
36-40	1.00	1.00	1.00	1.00
41-45	0.91	0.96	0.91	0.96
46-50	0.82	0.90	0.79	0.91
51-55	0.70	0.84	0.67	0.87
56-60	0.57	0.78	0.53	0.82
61-65	-	0.71	-	0.76
66-70	-	0.64	-	0.70
71-75	-	0.55	-	0.65
76-80	-	0.45	-	0.59
81-85	-	-	-	0.51
86-90	-	-	-	0.43
91-95	-	-	-	0.35

ตารางที่ 5-44

ตัวคูณปรับค่าอุณหภูมิโดยรอบแตกต่างจาก 30 °C ใช้กับค่าขนาดกระแสของเคเบิล เมื่อเดินใต้ดิน

อุณหภูมิโดยรอบ (องศาเซลเซียส)	ฉนวน	
	PVC	XLPE หรือ EPR
11-15	1.18	1.12
16-20	1.12	1.08
21-25	1.07	1.03
26-30	1.0	1.0
31-35	0.94	0.96
36-40	0.87	0.91
41-45	0.80	0.86
46-50	0.71	0.82
51-55	0.62	0.76
56-60	0.51	0.70
61-65	-	0.65
66-70	-	0.57
71-75	-	0.49
76-80	-	0.41

ตารางที่ 5-45

ตัวคูณปรับค่าสำหรับสายเคเบิลแกนเดี่ยว หรือหลายแกน ขนาดแรงดัน (U₀/U) ไม่เกิน 0.6/1 กิโลโวลต์ ผังดินโดยตรง เมื่อวางเป็นกลุ่มมากกว่า 1 วงจร วางเรียงกันแนวระดับ

จำนวนวงจร	ระยะห่างระหว่างผิวด้านนอกเคเบิล แต่ละวงจร (มม.)				
	วางชิดกัน	เส้นผ่านศูนย์กลาง เคเบิล 1 เส้น	125	250	500
2	0.75	0.80	0.85	0.90	0.90
3	0.65	0.70	0.75	0.80	0.85
4	0.60	0.60	0.70	0.75	0.80
5	0.55	0.55	0.65	0.70	0.80
6	0.50	0.55	0.60	0.70	0.80

ตารางที่ 5-46

ตัวคูณปรับค่าสำหรับสายเคเบิลแกนเดี่ยว หรือหลายแกน ขนาดแรงดัน (U₀/U) ไม่เกิน 0.6/1 กิโลโวลต์ ร้อยท่อผังดิน โดยตรง เมื่อวางเป็นกลุ่มมากกว่า 1 วงจร วางเรียงกันแนวระดับ

จำนวนวงจร	ระยะห่างระหว่างผิวด้านนอกท่อ แต่ละวงจร (มม.)			
	วางชิดกัน	250	500	1,000
2	0.85	0.90	0.95	0.95
3	0.75	0.85	0.90	0.95
4	0.70	0.80	0.85	0.90
5	0.65	0.80	0.85	0.90
6	0.60	0.80	0.80	0.90

ตารางที่ 5-47
รูปแบบการติดตั้งอ้างอิง

วิธีการเดินสาย	รูปแบบการติดตั้ง	ลักษณะการติดตั้ง	หมายเหตุ
สายแกนเดี่ยวหรือหลายแกนหุ้มฉนวน มี/ไม่มีเปลือกนอก เดินช่องเดินสายโลหะหรือโลหะภายในฝ้าเพดานที่เป็นฉนวนความร้อน หรือผนังกันไฟ		กลุ่มที่ 1	ฝ้าเพดาน หรือผนังกันไฟที่เป็นฉนวนความร้อนคือวัสดุที่มีค่าการนำทางความร้อน (thermal conductance) อย่างน้อย $10 \text{ W/m}^2 \cdot \text{K}^*$
สายแกนเดี่ยวหรือหลายแกนหุ้มฉนวน มี/ไม่มีเปลือกนอก เดินในช่องเดินสายโลหะหรือโลหะเดินเกาะผนังหรือเพดาน หรือฝังในผนังคอนกรีตหรือที่คล้ายกัน		กลุ่มที่ 2	กรณีฝังในผนังคอนกรีตหรือที่คล้ายกันผนังนั้นจะต้องมีค่าความต้านทานความร้อน (thermal resistivity) ไม่เกิน $2 \text{ K} \cdot \text{m/W}$
สายแกนเดี่ยวหรือหลายแกนหุ้มฉนวนมีเปลือกนอก เดินเกาะผนังหรือเพดาน ที่ไม่มีสิ่งปิดหุ้มที่คล้ายกัน		กลุ่มที่ 3	-
สายเคเบิลแกนเดี่ยวหุ้มฉนวน มี/ไม่มีเปลือกนอก วางเรียงกันแบบมีระยะห่าง เดินบนฉนวนลูกถ้วยในอากาศ		กลุ่มที่ 4	ระยะห่างถึงผนังและระหว่างเคเบิลไม่น้อยกว่าเส้นผ่านศูนย์กลางเคเบิล
สายแกนเดี่ยวหรือหลายแกนหุ้มฉนวนมีเปลือกนอก เดินในท่อโลหะหรือโลหะฝังดิน		กลุ่มที่ 5	-
สายแกนเดี่ยว หรือหลายแกน หุ้มฉนวน มีเปลือกนอก ฝังดินโดยตรง		กลุ่มที่ 6	-

ตารางที่ 5-47 (ต่อ)
รูปแบบการติดตั้งอ้างอิง

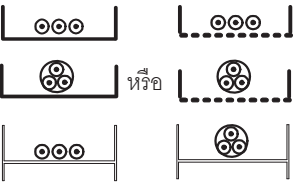
วิธีการเดินสาย	รูปแบบการติดตั้ง	ลักษณะการติดตั้ง	หมายเหตุ
สายเคเบิลแกนเดี่ยวหรือหลายแกนหุ้มฉนวน มีเปลือกนอก วางบนรางเคเบิลแบบด้านล่างที่บ, รางเคเบิลแบบระบายอากาศ หรือรางเคเบิลแบบแบนได		กลุ่มที่ 7	รางเคเบิลแบบระบายอากาศจะต้องมีพื้นที่ระบายอากาศไม่น้อยกว่าร้อยละ 30 ของพื้นที่ผิวรางเคเบิลทั้งหมด

หมายเหตุ (ตารางที่ 5-47)

*หากไม่มีเอกสารยืนยันว่าค่าการนำความร้อนมีค่าน้อยกว่า $10 \text{ W/m}^2 \cdot \text{K}$ ให้ถือว่าการเดินสายร้อยท่อภายในฝ้าเพดาน หรือผนังกันไฟใดๆ จะต้องมียุทธศาสตร์ตามลักษณะการติดตั้งตามกลุ่มที่ 1 นี้ ระบุไว้

ตารางที่ ร.3 แรงดันตกสำหรับสายไฟฟ้า ฉนวน XLPE แกนเดียว ที่ 90°C

ขนาดสาย (mm ²)	1 เฟส AC (mV / A / m)			3 เฟส AC (mV / A / m)			
	รูปแบบการติดตั้ง						
	กลุ่มที่ 1, 2	กลุ่มที่ 3, 7		กลุ่มที่ 1, 2	กลุ่มที่ 3, 7		
		Touching	Spaced		Trefoil	Flat	Spaced
1.0	46	46	46	40	40	40	40
1.5	31	31	31	27	27	27	27
2.5	19	19	19	16	16	16	16
4	12	12	12	10	10	10	10
6	7.9	7.9	7.9	6.8	6.8	6.8	6.8
10	4.7	4.7	4.7	4.0	4.0	4.0	4.0
16	2.9	2.9	2.9	2.5	2.5	2.5	2.5
25	1.85	1.85	1.85	1.60	1.57	1.58	1.60
35	1.37	1.35	1.37	1.17	1.14	1.15	1.17
50	1.04	1.00	1.02	0.91	0.87	0.87	0.90
70	0.75	0.70	0.73	0.65	0.61	0.62	0.64
95	0.58	0.52	0.56	0.50	0.45	0.46	0.50
120	0.49	0.42	0.47	0.42	0.37	0.38	0.42
150	0.42	0.36	0.40	0.37	0.31	0.33	0.37
185	0.37	0.31	0.35	0.32	0.26	0.27	0.31
240	0.32	0.25	0.30	0.27	0.22	0.23	0.27
300	0.28	0.22	0.26	0.24	0.19	0.20	0.24
400	0.25	0.19	0.23	0.22	0.17	0.18	0.22
500	0.23	0.17	0.21	0.20	0.15	0.16	0.20

ตารางที่ ฐ.4 แรงดันตกสำหรับสายไฟฟ้า ฉนวน XLPE หลายแกน ที่ 90°C

ขนาดสาย (mm ²)	1 เฟส AC (mV / A / m)	3 เฟส AC (mV / A / m)
	ทุกกลุ่มการติดตั้ง	ทุกกลุ่มการติดตั้ง
1.0	46	40
1.5	31	27
2.5	19	16
4	12	10
6	7.9	6.8
10	4.7	4
16	2.9	2.5
25	1.85	1.60
35	1.35	1.15
50	0.99	0.86
70	0.68	0.60
95	0.52	0.44
120	0.42	0.36
150	0.35	0.31
185	0.30	0.25
240	0.24	0.22
300	0.21	0.18
400	0.19	0.16

Another important factor for the determination of the conductor size is maximum allowable current during a short circuit when the maximum allowable conductor temperature is higher than during normal operation.

The maximum permissible short circuit of XLPE cables up to 1kV with copper conductors can be calculated with following formula:

$$1k = \frac{S}{\sqrt{t}} * K$$

Where
 1k = Maximum permissible short circuit current in Ampere
 S = Conductor area in mm²
 t = Duration of short circuit process in seconds. Maximum value for t = 5 second
 K = Constant of 143 for copper conductors and temperature rising 90 degree C to 250 degree C

Copper Conductors

The values of fault current given in the graph are based on the cable being fully loaded at the state of the short circuit (conductor temperature 90°C) and a final conductor temperature of 250°C, and it should be ensured that the accessories associated with the cable are also capable of operation at these values of fault current.

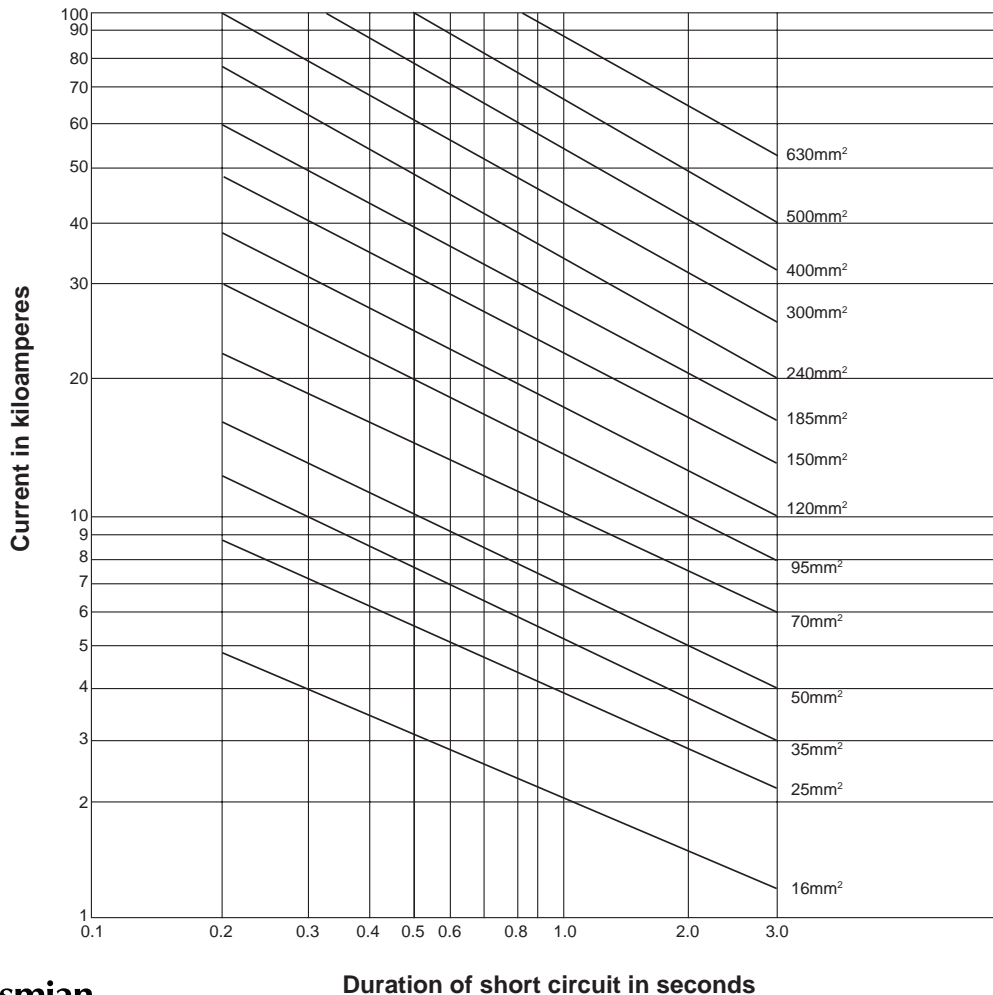

Maximum conductor resistance

Table 15

Cross Section Area (S) mm ²	Conductor for fixed wiring Class 1 (solid) Class 2 (stranded) ohm/km at 20°C
0.50	36.0
0.75	24.5
1.00	18.1
1.50	12.1
2.50	7.41
4	4.61
6	3.08
10	1.83
16	1.15
25	0.727
35	0.524
50	0.387
70	0.268
95	0.193
120	0.153
150	0.124
185	0.0991
240	0.0754
300	0.0601
400	0.0470
500	0.0366
630	0.0283
800	0.0221
1000	0.0176

Electrical Characteristics

Table 16

Conductor Resistance Temperature Correction Factors			
Temp°C	Factor	Temp°C	Factor
10	0.961	25	1.020
11	0.965	30	1.039
12	0.969	35	1.059
13	0.972	40	1.079
14	0.976	45	1.098
15	0.980	50	1.118
16	0.984	55	1.138
17	0.988	60	1.157
18	0.992	65	1.177
19	0.996	70	1.196
20	1.000	75	1.216
21	1.004	80	1.236
22	1.008	80	1.255
23	1.012	90	1.275
24	1.016		

Australia

Cross City Tunnel
Eastern Distribution Tunnel
Lane Cove Tunnel
M5 Motorway
Parramatta Rails
Proggo Road Busway

Brunei

700 Units Housing Development
Balai Bomba at Perumahan Kg Bt Beruang, Tutong
Balai Bomba Dan Perumahan Kampong Mentiri
BLNG / Refinery CCTV
BLNG Cooling Tower
BLNG Power Plant
Brunei Methanol Plant
BSP CER (Containerised Equipment Room)
BSP DATA Centre
BSP Maggie Platform
BSP Mampak Platform
BSP Seria North Flank
BSP Supplies
BSP Tank Major Repair
Centre Point Hotel upgrading
DES Supplies
DES Supply
Empire Hotel upgrading
Kg Kilanas Mosque
Kilap Mall
Light Industry Show at Kg Katimahar, Sengkurong
Magistrate Court
Maraburong Prison
Naval Base
New Building For Brunei Muara District
Radio TV Brunei
RTB (Radio TV Brunei)
SCOT Rejuvenisation
Shell Brunei Refinery
Tutong Street Lighting
Various Schools

Hong Kong

Caribbean Coast
Disneyland
Elements Shopping Center
Enterprise Square Five Mega Box Mall
Four Season Hotel
Grand Promenade
Harbor Front Horizon
Hong Kong International Airport
Hong Kong Science Park
Hong Kong-Shenzhen Western Corridor Bridge
ICAC Headquarter
Kowloon, Tsingyi, Iai King, Olympic, Tsuen Wan
West MRT Station
Movie City
One Beacon Hill
Pok Oi Hospital
Taiwan, Kam Sheung, Fotan MRT stations

Indonesia

Australia Embassy
British Embassy
Ciputra World
DATA Centre at Surabaya
Kemang Village Apt
Life Style Kuta Bali
LOTTE Mart Bintaro
Mall Summarecon
Mayapada Hospital
SILOAM Hospital
ST Moritz
TANG City Mall
TEMPO Scan
TRANS Studio Bandung

Macau

Macao Sands Casino
Macua Airport Extension
Ponte 16 Casino
Venetian Expo, Theater & Arena
Venetian Parcel 1 Casino

Malaysia

ALAM DAMAI
BANK NEGARA
Bank Negara Malaysia, Cyberjaya
BASF Gebeng, Petronas
CAPITAL SOAURE KL
Customs Kelantan

CX5

CYBERJAYA PRIMA 9 & 10
CYGAL PROPERTIES
Good Wood Hotel, JB
GOOGLE DATA CENTER
Jatya Jusco, Bukit Indah, JB
JB Project
KINRARAS MAS PUCHONG
KLIA 2 MOV COMMUNICATION
KLIA SPUR LINE
Kuantan & Segament Compressor Expansion Project
LHDNM – CYBERJAYA
Light Rail Transit Station
LOT C, KLCC
LYNAS
MCOT Petronas
Megasteel
MELODY HOME PROJECT
MEMC
Midvalley Magamall
MLNG – Fire & Gas System, Metering Station 1
MyDin Hypermarket
PACIFIC FOOD
PAHLAWAN
PAJAM SOLAR FARM
PEMBINAAN PEJABAT TANAH & GALIAN PAHANG
Petronas Refinery Melaka
Petronas Twin Towers
RAUB AUSTRALIAN GOLD MINE PROJECT
S-COGENERATION Project
SGL CARBON BANTING
Shell offshore Platform B11, F6, F26
SMART Tunnel Project
SPMY – HK SL SUNPOWER
SUBANG AVENUE
SUNPOWER PROJECT SITE (SPMY-HK BL)
Tawakai Hospital
Teluk Salut, Tanhill Power
Tenaga National Berhad SCADA System
TNB
TNB SCADA System
UOA Holding Berhad – 2 Block Condominium at Bangsar South
UTUSAN MALAYSIA
Wisma Lee Rubber
WISMA PERSEKUTUAN AT MITC MELAKA
WTP

Singapore

A post Bizhub
Aistom Metropolis C830
Anchor Handling Tug/Supply AHTS – Ice Class
Breadtalk Building
CAAS Terminal 3 CCTV
Changi Airport T3
Changi International Airport
Changi PMS Electrical Works
Changi Prison CCTV
Changi Water Reclamation Plant
Circle Line Stage 3 – Mechanical
Circle Line Stage 3, 4, 5 – Electrical
Common Service Tunnel – Marina
Credit Suisse Datacenter
Deutsche Bank @ Mapletree Business City
Downtown line single package, C955, C956, C960, C961
Downtown Ling State 1 (M&E)
Downtown Ling State 2 (M&E)
Exxon Mobile Singapore Parallel Train, Jurong Island
Exxon Mobile Singapore Parallel Train 2, Jurong Island
Formula One Grand Prix – Pitstop
Formula One Night Race
Garden by the Bay
HDB Commercial, Industrial & Residential Buildings
Ion Orchard
Islamic Hub
Kallang Paya Lebar Expressway
LTA Circle Line C830, C414
LTA KPE Expressway C415
Management Development Institute of Singapore (MDIS)
Marina Coastal Expressway C461
Marina Coastal Expressway C466
Marina Sands Integrated Resort
MSD Pharmaceutical Facility
North South Line Extension (Electrical), C1565

North South Line Extension (Mechanical), C1563

Orchard Gateway
Orchard Turn Shopping Center
OTS10 (Oil Tanking) Project
Oxley Bizhub 1 & 2
Presidential ISTANA CCTV
PSA Corporation Harbor projects
Regal Theatre
Renewable Energy Consortium
Savvis Datacenter
Schering Plough Expansion
SG2 Equinox Datacenter
SGH Heart Center
SGH Pathology Center
Shell Bukom C2 Jetty
Shell Houdini, Bukom Refinery
Shell MEG Air Liquide Project
Singapore Sports Hub
St James Power Station
The Baywater Condo
The Pier@ Robertson Quay
The Pinnacle Collection, Sentosa Cove
The SAIL Condo
Tuas Incineration Plant
Tuas undersea Tunnel
UE Bizhub East @ Changi Business Park
Vopak Horizon Project P11 & P111
Yen San Building, Orchard
Yong Loo Lin School of Medicine
Zion Bishan Bible – Presbyterian Church

Thailand

Airport Rail Link
Ban Rachaprasong Rachadomri
Bangchart Combine Heat & Power Plant
Bangkok Bank Building
Bangkok Metropolitan Administration
Bangkok Transit Systems (BTS)
Bangsui Watereastment
Baromchonranee Tunnel Road
BNC
Chulalongkorn University
Expressway Thailand Authority
Glow Power 115 MW CFB#3
Honda New Factory – 3
Jasmine Telecom
KLT – 8
Love Beach Hotel
LP Hospitality
Mahidol University (Dentistry Department)
Maneeya
Mass Rapid Transit System (MTRA – Blue Line)
MEA 230 KV Transmission Tunnel
MEA 230KV Underground Transmission Line
Between Bangkok and Chidlom
MEA PM2-0030-WBA Modification of 69 Kv Circuit
Breaker 9 Substations
Novotel Airport Hotel
Pre Clinic Siriraj Hospital
Prin Natathiwat, Prin Ratchaprerob
PTT RSP & GSP#6 Plant
Ramkamhang University
Ricoh (RMT) New Factory
Samart Ministry of Defense Southern Province
CCTV
SCB Data center
Siam Cement Group Chemicals THPP#3
Suvanabhumi International Airport (SBIA)
Thammasat University Rangsit
Thappline – Ethanol & Gasohol
The RoomRadchada
Triple T Broadband Project
True Multimedia
United International Highway

Vietnam

Ca Mau Pipeline
Can Tho Airport
Dung Quat Oil Refinery
Fideco Building, HCMC
Gemadep Tower
Hanoi Museum
Hyatt Hotel
IndoChina Plaza Hanoi
Park Hyatt HCM
RMIT University HCM
Saigon Pearl Condominium
Thi VI LPG Storage Tanks Development
Vietcombank Tower HCM

Certification Partners



PRYSMIAN GROUP-THAILAND MCI-DRAKA CABLE CO LTD

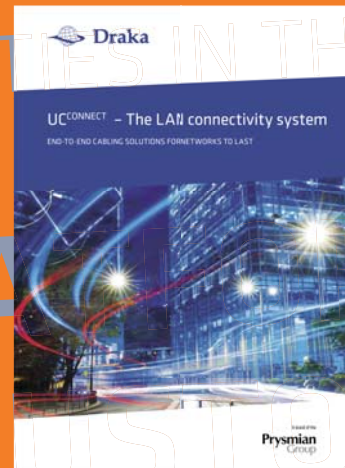
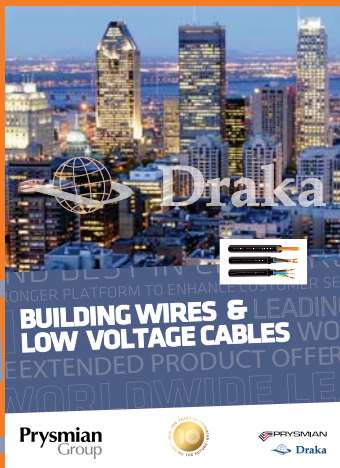

MCI-Draka Cable Co., Ltd.
18th Floor, Bangkok Tower 2170 New Petchburi Rd.,
Bangkapi, Huaykhwang, Bangkok 10310
www.prysmiangroup.com



www.draka.co.th